

Technical

Manual

BEVMAX

4

MODEL 5800-4

Glassfront Vender

Models DN5800-4, DN5800-E4, DN3800-4, DN3800-E4
Production Run 8882AH & higher



Tier 2



**Operation
Service
Parts
Troubleshooting
Manual**

Manufactured by

CRANE

MERCHANDISING SYSTEMS

Crane Merchandising Systems
P.O. Drawer 719
Williston, SC 29853-0719
803-266-5001
fax: 803-266-5049
Visit us on the web:
www.dixienarco.com

803,904,640.21

Table of Contents

GENERAL INFORMATION	4
Vender Safety Precautions.....	4
Product Identification.....	4
Physical Characteristics.....	4
INSTALLATION & SETUP	4 - 10
Receiving Inspection.....	4
Unpacking the Vender.....	4 - 5
Electrical Requirements.....	5
Power Supply & Grounding Requirements.....	5 - 6
Installation & Setup Instructions.....	6 - 7
Placing the Vender on Location.....	7
Acceptable Ambient Operating Temperature Range.....	7
Leveling the Vender.....	7 - 8
Spacing the Vender.....	8
Installing Labels & Product ID Cards.....	8
Coin Changers and Other Accessories.....	8
Set Temperature Control.....	8 - 9
Loading the Vender.....	9
Loading the Coin Changer.....	9
Power AC Distribution Box.....	9
Vending Machine Controller (VMC).....	9
Keypad.....	9
Digital Display.....	9
Refrigeration System.....	9
Shelf Assembly.....	9
Double Gate Assembly.....	9 - 10
Slide / Pusher Assembly.....	10
Deliver (Picker) Cup Assembly.....	10
Refrigeration Deck Clamp Assembly.....	10
Belt Tensioning Adjustment Components.....	10
PROGRAMMING	11 - 30
General.....	11
External Display Items.....	11
Normal Operation Messages.....	11
Initial Programming.....	11 - 12
Quick Reference Menu Items.....	13 - 14
Service Mode.....	15 - 17
Test Mode.....	17 - 22
Setup Mode 1.....	22 - 25
Setup Mode 2.....	25 - 27
Setup Mode 3.....	27 - 28
Satellite (137 / 937 Satellite) Mode.....	29 - 30
MAJOR COMPONENT DESCRIPTION	30 - 31
AC Distribution Box.....	30 - 31
GENERAL MAINTENANCE	31 - 32
Power.....	31
Cleaning.....	31 - 32
CONTROL BOARD	33
Controller Connections.....	33
TROUBLESHOOTING	34 - 53
XY Issues.....	34 - 36
XY Not Working Flow Chart.....	37
Plunger Home (Red Light) Flow Chart.....	38
X Axis Home (Yellow Light) Flow Chart.....	39
Y Axis Home (Green Light) Flow Chart.....	40
XY Slams to Top/Right or Left Flow Chart.....	41
Picker Cup Not Working Flow Chart.....	42
Picker Cup at Wrong Location Y Axis Flow Chart.....	43

Picker Cup at Wrong Location X Axis Flow Chart.....	44
Delivery Port Door Flow Chart.....	45
Coin Acceptance.....	46
Bill Acceptors.....	46
Control Board.....	46
All Coins Rejected Flow Chart.....	47
All Bills Rejected Flow Chart.....	48
Incorrect Change Dispensed Flow Chart.....	49
Selection Will Not Vend Flow Chart.....	50
Ice / Frost on Evaporator Flow Chart.....	51
Condensate on Outside of Product Door Flow Chart.....	51
Compressor Will Not Stop Flow Chart.....	51
Compressor Will Not Start Flow Chart.....	52
Machine Not Cooling Flow Chart.....	53
ELECTRICAL DIAGRAMS & SCHEMATICS.....	54 – 66
Block Diagram Domestic.....	54
Block Diagram Export.....	55
Vender Wiring Diagram Cabinet (Domestic & Export).....	56 - 57
Vender Wiring Diagram Door (Domestic & Export).....	58
Vender Wiring Diagram Power & Fluorescent Lighting (Domestic only).....	59
Vender Wiring Diagram Power & Fluorescent Lighting (Export only).....	60
Vender Wiring Diagram Power & LED Lighting (Export only).....	61
Vender Wiring Diagram Power & LED Lighting (Domestic only).....	62
Compressor Parts Diagram - Domestic.....	63
Compressor Parts Diagram - Export.....	64
AC Distribution Box Connector Voltages - Domestic.....	65
AC Distribution Box Connector Voltages - Export.....	66
PARTS LIST AND DIAGRAMS.....	67 – 102
Machine Front View.....	69 – 70
Cabinet Detail Product Area.....	71 – 72
Cabinet Detail Service Door Area.....	73 - 74
XY Motor Picker Unit.....	75 – 76
Picker Cup Assembly.....	77 – 78
Service Door Outside.....	79 – 80
Service Door Inside.....	81 – 82
Gate Tray Detail.....	83 – 88
AC Distribution Box.....	88 - 86
Lighting - Fluorescent.....	87
Lighting - LED.....	88
Refrigeration Unit Fin & Tube Condenser w/ Plastic Evap Box.....	89 – 90
Refrigeration Unit Fin & Tube Condenser w/ Metal Evap Box.....	91 – 92
Electronics.....	93 - 94
Harnesses.....	95 – 96
Labels / Decals / Misc.....	97 - 98
Screws & Nuts.....	99 – 100
Washers, Bolts, & Misc. Hardware.....	101 – 102



High Voltage Warning / Electrical Warning
Danger electricity, electric shock.



A Generic Warning.



Hazard Warning: Beware of moving machinery –
Entanglement hazard. Keep hands, loose clothing,
and long hair away from moving parts.

VENDER SAFETY PRECAUTIONS

Please read this manual in its entirety. This service information is intended for use by a qualified service technician who is familiar with proper and safe procedures to be followed when repairing, replacing or adjusting any Crane Merchandising Systems Dixie-Narco vender components. All repairs should be performed by a qualified service technician who is equipped with the proper tools and replacement components, using genuine Crane Merchandising Systems factory parts.



REPAIRS AND/OR SERVICING ATTEMPTED BY UNQUALIFIED PERSONS CAN RESULT IN HAZARDS DEVELOPING DUE TO IMPROPER ASSEMBLY OR ADJUSTMENTS WHILE PERFORMING SUCH REPAIRS. PERSONS NOT HAVING A PROPER BACKGROUND MAY SUBJECT THEMSELVES TO THE RISK OF INJURY OR ELECTRICAL SHOCK WHICH CAN BE SERIOUS OR EVEN FATAL.

PRODUCT IDENTIFICATION

First production of BevMax 4 5800-4/3800-4 Domestic and BevMax 4 5800-E4/3800-E4 Export Venders was March/April 2009. The production date of Crane Merchandising Systems Dixie-Narco products is determined by the date code incorporated in the serial number.

The vender serial number takes the form xxxx-yyyy zz. The first 4 digits (xxxx) identify the specific vender. The next 4 digits (yyyy) identify the manufacturing run that the vender was built in. The last two alpha characters (zz) identify the quarter and the year the vender was built. The first alpha character identifies the quarter as follows:

A= 1st Quarter
 B= 2nd Quarter
 C= 3rd Quarter
 D= 4th Quarter

The second alpha character identifies the year:

H = 2009 L = 2013
 I = 2010 M = 2014
 J = 2011 N = 2015
 K = 2012 O = 2016

CE Mark & IIA Declaration:

An updated CE Mark or IIA Declaration document can be provided upon request: If needed please contact Technical Support Manager in Williston, SC. Phone: Bryan Staubs 1- 803-266-8805 or email bstaubs@cranems.com.

PHYSICAL CHARACTERISTICS

	DN5800-4 DN5800-E4	DN3800-4 DN3800-E4
HEIGHT	72" (1828.8 mm)	72" (1828.8 mm)
WIDTH	47" (1193.8 mm)	39" (990.6 mm)
DEPTH CABINET	32" (812.8 mm)	32" (812.8 mm)
DEPTH WITH SERVICE DOOR	33.5" (850.9 mm)	33.5" (850.9 mm)
BASE	3.5" (88.9 mm)	3.5" (88.9 mm)
SHIPPING WEIGHT	764 lbs. (346.54kg)	675 lbs. (306.17g)
Noise Level	Operates at < 70db.	
Glass door width is 37.5" (952.5 mm) 5800's, 28.1" (713.74 mm) 3800's, height is 68" (1727.2 mm) both.		

RECEIVING INSPECTION

DO NOT STORE THE VENDER OUTSIDE.

Upon receipt, inspect the vender for any shipping damage. If there is any damage, have the delivery driver note the damage on the bill of lading and notify Crane Merchandising Systems. Although the terms of sale are FOB shipping point, which requires the consignee to originate shipping damage claims, Crane Merchandising Systems will gladly help if you must file a claim.

UNPACKING THE VENDER

Remove the stretch wrap, fiberboard edge protectors and corrugated front protector from the outside of vender.



Do not store the vender with stretch wrap on. Stretch wrap could bond to the vender's surface, which could damage the finish.

Remove the shipping boards from the bottom of the vender. The shipping boards are attached by the leveling legs. To avoid unnecessary damage to the leveling legs or base, remove the shipping boards by using a 1-1/2 inch or 38mm socket type wrench to unscrew the leveling legs. Be sure to replace the legs after removing the shipping boards. Once the skid

boards are removed there is 3" (76.2 mm) from base flange to the floor with the leveling legs screwed all the way in.

Once the vender is unpacked, check the "B" Tray area for any additional parts, price/product labels, service/operation manual or other information concerning factory-equipped accessories such as coin mechanism and validator.

It is recommended the vender be vend tested before shipping to the location. See Page 8, "Test Mode", # 9 "Test Vend".



Warning

Note: Remove tape from ends of top lamp in the top lamp assembly after placing the Vender on location, but before plugging the Vender in to an AC power supply.



WARNING: TO AVOID THE POSSIBILITY OF A FIRE HAZARD, DO NOT STORE ANYTHING OR ALLOW DEBRIS OF ANY KIND TO ACCUMULATE IN THE BOTTOM OF THE SERVICE AREA, IN AND AROUND THE REFRIGERATION COMPARTMENT OF THE CABINET, OR IN FRONT OF THE EVAPORATOR AND CONDENSER COILS.



Warning

WARNING: ENSURE THAT POWER IS DISCONNECTED FROM THE VENDER BEFORE INSPECTING OR REPLACING THE LAMPS, OTHER ELECTRICAL COMPONENTS, OR WORKING WITH OR ADJUSTING THE VENDING MECHANISM. FAILURE TO COMPLY WITH THESE INSTRUCTIONS MAY SUBJECT THE USER TO THE RISK OF ELECTRICAL SHOCK OR MECHANICAL INJURY, WHICH CAN BE SERIOUS OR FATAL.



ELECTRICAL POWER NEEDED

Refer to the cabinet serial number plate to determine the correct voltage and frequency for the machine. In the US and Canada this is 120Vac, 60Hz, 1P. In Europe, Australia, and other export countries, this is 220/230/240Vac, 50Hz, 1P depending upon your country voltage. The serial plate also specifies the ampere rating of the machine. This machine must be plugged into a properly rated receptacle with its own circuit protection (fuse or circuit breaker).

Equipment Nominal Power Requirements -

120V / 10.2 A = *1224W (1.224kw)

220V / 5.8 A = *1276W (1.276kw)

240V / 5.8 A = *1392W (1.392kw)

*Note: Watts = V X A

DO NOT USE AN EXTENSION CORD.

POWER SUPPLY CORD and GROUNDING REQUIREMENTS

In accordance with the National Electrical Code and Underwriters Laboratories Inc., domestic vending machines are equipped with a three-wire power supply cord and Ground Fault Circuit Interrupter (GFCI). The GFCI device is provided as part of the power supply cord and is either incorporated directly into the plug or mounted on the cord adjacent to the plug.

WARNING

- The **GFCI** protects against current leakage caused by ground faults. The GFCI is not designed to protect against over current or short circuits.
- **DO NOT** use the TEST and RESET buttons on the GFCI as an ON/OFF switch.
- The vending machine supply cord **MUST** be plugged directly into a properly grounded, 3 wire receptacle that is properly protected by a fuse or circuit breaker. If the receptacle will not accept the power cord plug, it must be replaced with a properly grounded, 3 wire receptacle in accordance with the National Electrical Code and Local Codes and Ordinances. The work should be done by a qualified electrician. **DO NOT USE A 3 WIRE TO 2 WIRE ADAPTOR**



Warning



DO NOT REMOVE THE GROUND PIN ON THE PLUG OR IN ANY WAY BYPASS, MODIFY, DEFEAT, OR DESTROY THE GROUNDING SYSTEM OF THE VENDING MACHINE

- **DO NOT USE WITH AN EXTENSION CORD.**
- **DO NOT REMOVE THE WARNING TAG ATTACHED TO THE POWER SUPPLY CORD.**
- The GFCI must be tested frequently and before each use in accordance with the instructions provided on the GFCI device. **IF THE GFCI DOES NOT PASS THE TEST, DO NOT USE THE MACHINE.** Unplug the supply cord from the receptacle and call the Crane Merchandising Systems Technical Support Group for assistance at 1-803-266-5001.

It is recommended that the machine be located so that the GFCI device will be accessible after the machine is installed. After installation, visually inspect the GFCI and power supply cord to be sure it is not crushed, pinched, or stretched.

Protect the power supply cord during transportation and use. Periodically inspect the power supply cord for damage. If the cord or plug is worn or damaged, it must be replaced with a power supply cord of the same type, size and specification as originally provided with the machine. **DO NOT USE THE VENDING MACHINE UNTIL THE WORN OR DAMAGED CORD IS REPLACED.**

FAILURE TO COMPLY WITH THESE INSTRUCTIONS MAY SUBJECT THE USER TO THE RISK OF INJURY OR ELECTRICAL SHOCK WHICH CAN BE SERIOUS OR FATAL. PERIODICALLY INSPECT THE POWER SUPPLY CORD FOR DAMAGE. IF THE CORD BECOMES DAMAGED IT MUST BE REPLACED WITH THE SAME SIZE AND TYPE CORD. CONTACT CRANE MERCHANDISING SYSTEMS FOR ASSISTANCE.



INSTALLATION AND SETUP INSTRUCTIONS

ELECTRONIC LOCK

The electronic lock provided in the vender consists of a door mounted, motor driven 2 point latching system, cabinet mounted latch and strike system, an infrared controlled CPU, and a remote control key (FOB). The design is modular and allows for easy field service.

The electronic remote key (FOB) features a rolling code system which cannot be decoded if it is lost or stolen. After the vender has been unlocked, a new key can be programmed into it any number of times. If a key is lost or stolen, it is recommended you change the lock code in the field as soon as possible. Changing the lock code requires a new key and pressing the PROGRAM button on the lock inside the vender. The lock does not need to be changed for re-keying.

Important: For security reasons all Electronic Door Lock Venders are shipped less keys. Customers will need to contact the Electronic Door Lock manufacturer to order keys.

A power bypass connector, located in the product delivery port, allows auxiliary power to be applied via a battery pack to the electronic lock in the event that power is not available or there has been a failure of the internal power supply. In the event of an emergency, battery power is applied to the connector and the door can be opened and closed using the FOB.

The electronics uses an infrared transmission system, which functions similar to a television remote control. The transmission signal is line-of-sight, which requires you to aim the remote at a specific place at close range to prevent the accidental opening of several venders at the same time.

TO OPEN THE ELECTRONIC DOOR LOCK:

1. Plug the vender into a properly powered outlet.
2. Hold the key FOB 0 to 3" (76.2 mm) in front of the Delivery Port Door and press the button on the key FOB.
Note: The wide end of the FOB should face the door.
3. The lock will begin releasing the door. The display will indicate **OPENED**. After the motor has stopped running, you can pull the door open.

TO CLOSE THE ELECTRONIC DOOR LOCK:

CAUTION: DO NOT SLAM THE DOOR CLOSED.

Slamming the door closed can damage the electronic locking device.

1. Push the door to the cabinet until the lock motor starts. The display will indicate: **CLOSED**
2. Continue to push the door for approximately 2 to 3 seconds after the lock motor starts. The lock will pull the door closed tightly.
3. When the lock motor stops the door will be locked. Before leaving the vender, ensure that the door is locked.

The electronic door lock assembly is supplied by TriTeq Lock and Security. Crane Merchandising Systems does not carry parts for the TriTeq Electronic Door Lock.

For parts and assistance, please contact:

TriTeq
701 Gullo
Elk Grove Village, IL 60007
Tel: 847-640-7002
Fax: 847-640-7008
Email: triteqlock.com

MANUAL LOCK

Open the service door on the right side using the key provided in the coin return cup, or if shipped with a locking clip, remove the clip and install the lock. Ensure there is no power to the AC Distribution Box. On venders with a main power switch on the AC Distribution Box the switch needs to be in the OFF position. On venders with a main power quick disconnect plug on the AC Distribution Box the quick disconnect plug needs to be unplugged. Check that all connectors are firmly seated on the control board and at the various components on the service door (coin mech, keypad, etc.).

Retrieve the main power plug from the hole in the rear of the vender and plug the cord in a properly grounded 120VAC, 15 Amp receptacle (U.S. and Canada).

Open the service door and apply power to the AC distribution Box (if equipped with a bill acceptor, the acceptor should cycle twice). The display on the door will briefly show the software version in use as "Software ###.## (ie 70#. #1) followed by the default idle message "ENJOY A REFRESHING DRINK", the fluorescent lamp should be lit and the cooling unit should start. If the display shows "OUT OF SERVICE", or the cooling unit fails to start, refer to the TROUBLESHOOTING SECTION beginning on page 34.

SERVICE NOTE

Battery Backup

The battery backup is used to maintain the date and time in case of power interruptions, or any time the main power is off. When the vender is shipped, the battery is connected and memory is being maintained. If the vender is to be stored for long periods of time, disconnecting the battery is recommended. The following steps will guide you through this procedure.

- Open the service door, turn the main power switch to the off position or unplug the main power harness located on the front of the power box.
- Locate the control board mounted on the rear wall.
- Remove the battery from its holder (B1).

PLACING THE VENDER ON LOCATION

!! CAUTION !!



DO NOT TRANSPORT THE VENDER TO OR FROM THE LOCATION LOADED WITH PRODUCT OR DAMAGE TO THE VENDER MAY RESULT.

The vender is intended for **INDOOR USE ONLY**. It should be kept out of direct sunlight and away from any heat source. This machine is not suitable for installation in an area where a water jet or hose and nozzle may be used.

The vender must be on a solid, flat and level surface. Ensure the flooring can bear the weight load of a fully loaded vender (approximately 1109 lbs. or 413kg). The vender must be positioned close enough to an electrical outlet so that an extension cord is not required. If the machine will be subject to user misuse or vandalism, it is recommended that the vender be secured to the floor or wall as described in Crane Merchandising Systems / Dixie-Narco Technical Bulletin 344. Due to the large size and weight of the Vender, never attempt to move the Vender with a Hand Truck or Stair Climber. Use a pallet jack or Vender/Cooler Dollies at all times when moving the Vender. The vender should never be slid or pushed in place. Never side load the leveling legs; doing so will cause damage to the legs. Do not transport the vender to or from customer locations loaded with product, as damage may result due to excessive weight. Be sure to test vender for proper operation before putting in to service on location. Call the Crane Merchandising Systems Technical Service Department or your Crane Merchandising Systems Representative for assistance.

ACCEPTABLE AMBIENT OPERATING TEMPERATURE RANGE.

Generic and Pepsi BevMax 4 5800-4/3800-4 equipment manufactured by Crane Merchandising Systems is designed to work properly in a temperature range of 75°F to 90°F (23°C to 32°C) in still air 65% R.H. non-condensing.

LEVEL THE VENDER

Adjust the front leveling legs, ensuring that an even gap exists between the glass door and the top security angle and receiver box, and then level the cabinet front to rear. A carpenter's level will help verify that the vender is level. Leveling legs are adjusted using a wrench or socket 1 ½" or 38 mm in

size. If the vender is to be used in a bank of equipment, check the top and sides for proper alignment. If you are unable to properly level the vender, select an alternate location. NEVER PLACE OBJECTS UNDER THE LEVELING LEGS OF THE VENDER

DANGER

THE VENDER MUST BE PROPERLY LOCATED AND LEVELED. IF THE MACHINE WILL BE SUBJECT TO USER MISUSE OR VANDALISM IT IS RECOMMENDED THAT THE VENDER BE SECURED TO THE FLOOR OR WALL AS DESCRIBED IN CRANE MERCHANDISING SYSTEMS DIXIE-NARCO TECHNICAL BULLETIN 344 TO MINIMIZE THE RISK OF INJURY OR DEATH FROM TIPPING. CALL THE CRANE MERCHANDISING SYSTEMS TECHNICAL SERVICE DEPARTMENT OR YOUR CRANE MERCHANDISING SYSTEMS REPRESENTATIVE FOR ASSISTANCE.



SPACE THE VENDER

Do not block the rear of the vender. Maintain a minimum of 4 inches (10 cm) from the wall to ensure adequate airflow to the condenser and compressor. At the rear of the vender, make sure nothing obstructs the air exhaust at the bottom of the cabinet.

WARNING

TO AVOID THE POSSIBILITY OF A FIRE HAZARD, DO NOT STORE ANYTHING OR ALLOW DEBRIS OF ANY KIND TO ACCUMULATE IN THE BOTTOM OF THE DOOR, IN THE BOTTOM OF THE SERVICE AREA, IN AND AROUND THE REFRIGERATION COMPARTMENT OF THE CABINET, OR IN FRONT OF THE EVAPORATOR AND CONDENSER COILS.



INSTALLING PRICE LABELS

Pricing labels included in the literature package kit. Remove the pricing label sheets from the service manual package and gently remove the label corresponding to the vend price of each selection by tearing at the perforation. The label is installed at the top of the front knuckle. Once installed, push the label firmly against the front of the knuckle. This will insure the label is locked in place.

INSTALLING PRODUCT ID CARDS

To assist with consistent loading, product ID cards can be installed in the product pusher to designate to the route driver which product the column is set for. To install the flavor card, simply detach it from the sheet at the perforation and slide it into the slots in the product pusher. Contact your graphics supplier to purchase as needed.

COIN CHANGERS & OTHER ACCESSORIES

The vender can have an MDB coin changer installed and can have an MDB bill acceptor installed as well. Note: BevMax 4 5800-4/3800-4 will work with an MDB bill acceptor only. If the MDB coin changer and other MDB accessories are not factory installed, refer to the instructions received from the manufacturer of the MDB coin changer and other MDB accessories for proper set-up and installation.

The vender will support the following Domestic MDB coin changers:

- All available NRI MDB
- All available Coinco MDB
- All available Mars MDB
- All available Conlux MDB

The vender will support the following domestic MDB Bill validators:

- All available Cashcode MDB
- All available Coinco MDB
- All available Mars MDB
- All available Conlux MDB

The vender will support MDB card readers.

SETTING THE TEMPERATURE CONTROL

This vender is equipped with an electronic temperature sensor. Defrost is controlled both electronically based on run time of the compressor and with a manual Defrost thermostat. The temp sensor is factory pre-set to maintain a cabinet temperature of 37° Fahrenheit (2.7°C). It is also a good practice to ensure the proper operating temperature prior to installing the vender on location. To set the temperature, apply power to the vender and allow it to run for several hours with the glass door closed or until the minimum cabinet temperature is achieved. Then, using the method below, verify the temperature inside the cabinet:

With an electronic temperature sensor, use the keypad on the service door to show cabinet temperature in Fahrenheit by pressing the F key followed by the asterisk (*) key or in Centigrade by pressing the C key followed by the asterisk key. The temperature will be shown on the digital display located on the front of the service door.

The manual Defrost thermostat is located in the bottom left of the service area. The Defrost control is preset and is not adjustable.

LOADING THE VENDER

CAN/BOTTLE DRINK TRAYS

The BevMax 4 5800-4/3800-4 Vender does not require spacers or shims to vend most packages. Load product in each column one package at a time insuring that the package being loaded is in front of the product pusher. Insure that the package is stable within the column (doesn't move excessively from side to side). After loading the vender, test vend each column to insure proper operation. Please contact a Service Representative or refer to the proper Technical Publication for any special settings you may need.

LOADING CHANGE TUBES

The changer tubes can be loaded using one of the following methods:

1. Load the coin mechanism with coins to the desired level by inserting coins in the loading slots on the coin tube front.

Minimum coin tube levels are:

6-8 nickels

7-8 dimes

5-6 quarters

Note: A low coin level in the coin tubes will interfere with operation of the bill validator.

2. For exact cash accountability and to insure maximum dollar bill acceptance, load the mechanism utilizing the coin insert slot on the front of the vender while in the coin TUBE FILL/DISPENSE mode in the test menu in the programming section of Technical Manual for more information.

For additional information about coin mechanism, refer to the manufacturer's instructions.

POWER AC DISTRIBUTION BOX

The power distribution box is where the 120VAC or 220VAC input voltage is broken down to the main operating voltages of the vender (24 VAC and 12 VAC) by a transformer. Those voltages are sent to the controller via the P1 (3 pin) connector. Domestic Venders contain a 15 Amp Outlet which provides power to the Refrigeration Unit. It contains a main power switch/plug that allows power to the AC Distribution Box to distribute AC power to the lights, evaporator fan, and refrigeration system, which are always energized when the vender is powered up. It is located inside the service area, mounted to the back wall.

VENDING MACHINE CONTROLLER (VMC)

The vending machine controller is the heart of the Glass Front Vender and is located on the rear wall

inside the service area. It is flash programmable and may or may not include the program chip (EPROM), which controls all aspects of the vender. It also contains the power supply which regulates the voltages required to operate the motors as well as the coin mechanism, digital display, and all logic functions in the vender.

KEYPAD

The keypad is located on the front of the service door. It consists of a 6" X 3" (15.2 mm X 7.6 mm) matrix, tactile feel membrane switch pad and an overlay. The pad utilizes the letters A thru F on the left side and numbers 1 thru 0 along with the * symbol and Clr to the right. The keypad is where the vender programming is accomplished and where the customers make their selections.

DIGITAL DISPLAY

The digital display is located directly above the keypad on the front of the service door. It is used to convey information to the consumer as well as to the person programming the vender.

REFRIGERATION SYSTEM

The refrigeration system is a single piece unit and is hermetically sealed. The Model BevMax 4 units consist of a 1/3 plus horsepower compressor, with a single fin and tube style condensing unit with one condenser fan, condensation overflow pan, evaporator, and evaporator fan motor. The refrigeration unit is located behind the refrigeration unit cover panels, mounted in the bottom of the cabinet. This unit is designed for easy removal and replacement from the front or rear of the vender as a complete assembly. An electronic thermostat regulates the cabinet temperature. The control of the thermostat is attached to the evaporator coils and reads the temperature of air being pulled in to the evaporator coil.

SHELF ASSEMBLY

Typically, there are 5 shelf assemblies in every vender; however, this can vary depending upon the configuration specified at the time of ordering. Each can/bottle shelf consists of 9 or 7 columns. Each shelf is capable of holding a variety of packages. The shelf assembly consists of the tray, where all of the following parts are mounted: Double Gate assembly and the slide/pusher assembly. These items are discussed in detail below.

DOUBLE GATE ASSEMBLY (Can/Bottle Trays)

The double gate assembly is mounted on the front portion of the tray assembly and contains the vending mechanism. Incorporated in the gate assembly are the front and rear knuckle assemblies as well as the product kicker. In standby operation, the front knuckle

is in the blocking position, which holds the front displayed product in position to be vended. The rear knuckle assembly is in a flat position, which allows product to enter the gate area, and the kicker is flush to the rear knuckle assembly. A stainless steel pin is inserted through the rear most portion of the front knuckle assembly and connects to a gear box below the tray. When a selection is made, the plunger pushes the lever toward the back of the tray. At the same time the front knuckle is opened into a flat position, the rear knuckle is closed to a blocking position, holding the remaining product out of the gate area, and the kicker is extended to firmly push the front displayed product off of the tray. The plunger is energized for approximately 1-½ seconds to allow ample time for the displayed product to be ejected from the shelf. The plunger is then released and the front knuckle returns to the blocking position, the rear knuckle and kicker return to their standby position and the next product slides into the vend display position.

SLIDE/PUSHER ASSEMBLY (Can/Bottle Trays)

The slide/pusher is located on the bottom of each product column. Its purpose is to provide a slick, friction resistant surface for the product to rest on. The tall product pusher is mounted on the top of the slide and incorporates a coil spring in the body that attaches to the bottom of the slide through a slit. This spring adds needed tension to insure that all products in the column remain tight against each other and are allowed to progress into the gate area. Periodic cleaning and lubrication of the slides is recommended. **DO NOT USE SOLVENTS OR ABRASIVE MATERIALS TO CLEAN ANY PORTION OF THE TRAY.**

DELIVERY (PICKER) CUP ASSEMBLY

The delivery (picker) cup assembly is located on the XY vend mechanism. Its purpose is to pick the product from the column and deliver the product to the delivery port assembly. The delivery (picker) cup assembly is mounted on the XY assembly and bolts in position.

The X axis runs left to right. The X axis assembly is cabinet mounted to prevent any cabinet torque and has one belt to synchronize the top and bottom when the X moves left or right.

The Y axis runs up and down and has the delivery (picker) cup assembly attached. A top channel is used to contain and hide the e chain and wiring.

Both X and Y motors have encoders for positioning.

REFRIGERATION DECK CLAMP ASSEMBLY

The refrigeration deck clamp assembly is located on the rear left side of the cabinet base plate. Its purpose is to secure the refrigeration assembly tight against the vertical base plate for refrigerated air flow

in to the cabinet. A 7/16" wrench or socket is needed to adjust the bolt.

BELT TENSION ADJUSTMENT COMPONENTS

The belt tensioning adjustment components have been revised to ease adjusting belts when needed. The X Belt Idler Tensioning Assembly in the upper left hand corner of cabinet now includes a thumb screw. Adjustments should only be needed if a belt is replaced.

The Bottom X Drive Tensioner Assembly in the lower right hand corner of cabinet has a plastic spring loaded tensioning wheel to keep the belt against the pulley when moving and does not require any adjustments.

PROGRAMMING

GENERAL INFORMATION

In order to fully utilize the many features of your vender it is important that you first understand the options available and procedures for programming the vending controller unit (control board).

All programming, testing, and service functions are accomplished by using the keypad in an easy to follow, display prompted format. In stand alone operation there are four modes of operation for servicing, testing, and setting up your vender. If attached to a snack vender there are five modes of operation for servicing, testing, and setting up your venders. The modes of operation are accessed by, opening the service door, and pressing the service button on the control board.

The service button will cycle through each of the four (five) modes in turn: Service Mode, Test Mode, Set-Up Mode 1, Set-Up Mode 2, Set-Up Mode 3, and Satellite Mode (if a snack vender is attached). In each of these modes, the "A" key is used to scroll through the available options/settings within that mode/selection. (Note: In each of the mode selections, pressing the character key next to the listed option will take you directly to that feature - see menu items chart on pages 13 and 14.), the "*" key is used as an enter key to select the currently displayed item/feature, and the "CLR" key is used as a done or exit key. Closing the service door or pushing the service door switch will exit the function you are currently in and place the vender back in service.

EXTERNAL DISPLAY ITEMS (HOT KEYS)

Allows the service technician to view several items via the display without opening the vender. There are four options that can be viewed externally:

1. **Display temperature in degrees "C"**. To view, press the "C" then press the "*" key. The display will then show the vender's inside temperature in degrees "C".
2. **Display date/time**. To view, press the "D" key, then press the "*" key. The display will then show the current date and time.
3. **Display temperature in degrees "F"**. To view, press the "F" key, then press the "*" key. The display will show the vender's inside temperature in degrees "F".
4. **Display current software revision**. To view, press the "B" key, then press the "*" key. The display will then show the current software revision in the controller.

NORMAL OPERATION MESSAGES

At initial power-up, the program will start and the display will briefly show the software version in use as Software ###.## (i.e. 700.91), followed by the default

idle message, "ENJOY A REFRESHING DRINK" or "ENJOY A REFRESHING DRINK AND SNACK" when attached to a snack vender..

INITIAL PROGRAMMING

DATE/TIME

To set date/time enter "SETUP MODE 1" by opening the service door and pressing the Service Button three (3) times. Press the number "5" and "DATE/TIME" will show on display. Press the "*" key and display will show the current year, month, date, and time setting currently in the system in following format: 2005 Apr 28 15:45 with the year highlighted. Press the numbers to enter the current year and Month will then be highlighted. To change the month press the A key to scroll forward through the months or the B key to scroll backward through the months. With the correct month showing, press the "*" key to save and Date will then be highlighted. Press the numbers to enter the current date and then the hour will then be highlighted. Note: Hours are shown in 24 hour format. Press the numbers to enter the current hour and then the minutes will then be highlighted. Press the numbers to enter the current minutes. The display will then change to show "OK? *=Y (Yes) CLR = N (No)" and the setting you entered. You must press * Key to save the new date and time entered. Pressing CLR Key will revert to the date and time setting. Press the "CLR" key to return to "SETUP MODE".

SET PRICES

To set the prices enter the "SERVICE MODE" by opening the service door and pressing the Service Button once. Allows the setting of regular and secondary prices for an individual item, a complete tray, or the entire machine. Factory setting is \$99.95. Press the number "7" on the keypad and the display will show "SET PRICE". Press the "*" key and the display will show "1 = Regular Pricing, 2 = Secondary Pricing". To set regular prices press number 1 key and display will show "Regular \$##.##". To set price:

1. **All selections**. Press the keypad numbers of the price you wish to use. As numbers are entered the numbers will shift in from the right as they are entered. Note: The CLR key will remove the last # of the price. Once the desired price is showing on the display press the "*" key and the display will show "PR\$##.## All Set", press "*" to set more prices or CLR to return to SET PRICES. Press CLR Key again to return to SERVICE MODE.
2. **One tray**. Press the keypad numbers of the price you wish to use. As numbers are entered the numbers will shift in from the right as they are entered. Note: The CLR key will remove the last # of the price. Once the desired price is showing on the display press

the tray letter desired for setting price. Press “*” and display will show “PR ###.## B(tray letter) Row Set”, press “*” to set more prices or CLR to return to SET PRICES. Press CLR Key again to return to SERVICE MODE.

- 3. Single selection.** Press the keypad numbers of the price you wish to use. As numbers are entered the numbers will shift in from the right as they are entered. Note: The CLR key will remove the last # of the price. Once the desired price is showing on the display press the selection desired for setting price. Press “*” and display will show “PR ###.## B1 Selection Set”, press “*” to set more prices or CLR to return to SET PRICES. Press CLR Key again to return to SERVICE MODE.

The last price entered for a selection is the price that will be used. For example, If one price on the A tray was set to \$1.50 using option 3 above and you wish to change the remaining selections on that tray using option 2, the pricing for the entire tray would take precedence. Conversely, if the price was set using option 2 first followed by the single selection using option 3, the pricing for the remainder of the shelf would remain and the new price for the single selection would change to the new value. Press the “CLR” key to return to “SERVICE MODE”.

SET NOT AVAILABLE TIMES

Password protected. Before entering or changing this setting you must enter the password if one has been assigned. This mode allows up to 4 different time periods that use of the machine may be restricted. To set Not Available Times enter the “SETUP MODE 1” by opening the service door and pressing the Service Button 3 times. Press the number 3 key; the display will show “SET NOT AVAIL TIME”. Press the “*” key and the display will show “Select Block (1 – 4): Press number 1 Key to set Select Block 1 available

settings, Key 2 for Select Block 2, etc... Once you select the Select Block # you wish to set the display will show “Start MTWTFSS Stop 1 00:00 NNNNNNN 00:00” with the start time hour highlighted. Press the numbers to enter the hour you wish to start select block (Note: hour setting is in 24 hour format.) and then the minutes will be highlighted. Press the number keys to enter the minutes and then the first day of the weeks current setting will be highlighted. To change the setting to no press key 2, to yes press key 1. This will change each setting left to right one day at a time until all are set then Stop time hour will be highlighted. Press the numbers to enter the hour you wish to stop select blocking and the minutes will be highlighted. Press the numbers to set the minutes and the display will show “OK? * = Y CLR = N” press the * Key to save these settings or CLR Key not to save settings and display will change to show which selections are assigned to this block. Press * Key and display will show “Enter Selection”. Press the Keys of the selections you wish to disable followed by * and display will show “Disabled Continue? * = Y CLR = N”. Note: If you press a tray letter (ie A) followed by the * Key that entire tray will be set to be disabled. Once you have selected all settings and the display shows “Disabled Continue? Or Enabled Continued? **Note: display must show Display Enabled for the selection to shut down.** * = Y CLR = N (note: pressing clear will delete all settings you just set), press the CLR to return to “SET NOT AVAIL TIME”. Press CLR again to return to “SETUP MODE 1”. Once completed go to Test Mode, Not Available Mode (Key 3) and turn on Not Available Mode.

BevMax 4 5800-4/3800-4 Board Programming

Service Mode		Test Mode		Setup Mode 1		Setup Mode 2	
A	Step through below	A	Step through below	A	Step through below	A	Step through below
B	Cash Box	B	List Errors	B	Enter Message	B	STS Enabled/Disabled
C	Sales	C	Light Timer	C	Clear Message	C	Custom STS
D	Display Temperature	D	Enable Snack Menus	D	Enable/Disable \$	D	Default STS
E	Set Refrig. Temp.	E	Keypad Test	E	Set Happy Hour Time	E	Display STS
F	Clear Totals	F	*Factory Diagnostics	F	Master Reset	F	Set No Vend Limit
1	Number Sold	1	Tube Fill/Dispense	1	Machine Number	1	Multivend
2	Enable Item (Disable)	2	Daylight Savings	2	Set Happy Hour	2	Select Language
3	Sales by Column	3	Set Not Available	3	Set Not Available Time	3	Sold Out Enable
4	Escrow	4	Set Credit Timer	4	Consumer Overpay	4	Price Display
5	Force Vend	5	Door Open	5	Date/Time	5	Storage Temp Enable
6	Set Temp. (F or C)	6	Power out	6	Total Sales	6	Interval Sales Reset
7	Set Prices (Regular & Secondary)	7	Test Health Guard	7	Health Control	7	Set Lights Off
8	***Set Shelf Location (G, M1, M2, D, E, E1, D2)	8	Display Health Guard	8	Update Software	8	Double Talk
9	Relay Toggle Test	9	**Test Vend	9	Set Lights Off Time	9	Set Storage Time
0	Clear Errors	0	Show Checksum	0	Enter New Password	0	Set Storage Temp

***Factory Diagnostics – sub-menus**

A	Build ##### = software revision build number
B	Model # = Set Model Number DN5800-4, DN3800-4, DN5800-E4, DN3800-E4
E	Extended Cup = All BevMax 4 5800-4 - Enabled
F	Delivery (Picker) Cup Sensor Option = BevMax 4 5800-4 with cup sensor set ON, BevMax 4 5800-4 with out cup sensor set OFF.
1	Position Test = F – goes home; 0 – cycles plunger; * - stops all motors; Shelf letter – moves cup to shelf selected; Column # - moves cup to column selected.
2	Port Test = A – opens port; B – closes port; C – sensor test ON; D – sensor test OFF; E – cup LED's on; F – port LED's on; * - All Stop.
3	Delivery (Picker) Cup Check = “On (status of cup sensor):#”; “In (detects product in cup):#”; “Out (picker out switch status):#”; “Hm (picker home switch status):#”.
4	Repeat Vend
5	Vend Error Codes = Factory Use Only / Do Not Use.
6	Product Sensors = All BevMax 4 5800-4 set ON
7	Factory Use Only / Do Not Use
8	Shelf Offset = BevMax 4 5800-4 Shelf Location “D2” = 700
9	(Not Used)
0	Hook Swipe X = sets far right travel distance to Delivery door (BevMax 4 5800-4 factory default = 93871).

****Test Vend** = Test Mode press “9” and “*” (enter) to get to “**Enter Selection**”. Close the service door and choose desired selection to test vend.

To set Timers for schools = Set Date/Time / Set Not Available blocks / Set Not Available Times / Set Daylight Savings Time

Cash and Sales Numbers = Sales / Number Sold / Sales by Column / Total Sales / Cash Box

*****Set Shelf Location** = Service Mode press “8” - BevMax 4 5800-4 = D2 – Domestic, E3 - Export 5 Shelf, E4 – Export 4 Shelf (default is 700)

Set Hook Swipe X = Test Mode press “F” and “*” (enter) to get to “**Factory Diagnostics**”. Press “8” and “*” (enter) to get to Hook Swipe ##### (default is 91871).

BevMax 4 5800-4/3800-4 Board Programming

SETUP MODE 3		Satellite Mode (137/937)	
A	Step through below	A	Step through below
B	EXE OR MDB	B	(Not Used)
C	Set Pricing Mode	C	Set SAT Price (Satellite only)
D	Assign Priceline	D	Enable Combo Discount
E	View PL Assignments	E	Number Combo Discount
F	View PL Value	F	(not used)
1	Quick Payback	1	Set Golden Eye Policy
2		2	Set Golden Eye Selections
3		3	Check Motor Scan (press #1)
4		4	Set Credit Return Timeout
5			
6			Use other Setup Modes for:
7			Multivend: Setup Mode 2 key 1.
8			Set Not Available: Test Mode key 3.
9			Set Not Available Time: Setup Mode 1 key 3.
0			Test Vend: Test Mode key 9

*Factory Diagnostics – sub-menus

A	Build ##### = software revision build number
B	Model # = Set Model Number DN5800-4, DN3800-4, DN5800-E4, DN3800-E4
E	Extended Cup = All BevMax 4 5800-4 - Enabled
F	Delivery (Picker) Cup Sensor Option = BevMax 4 5800-4 with cup sensor set ON, BevMax 4 5800-4 with out cup sensor set OFF.
1	Position Test = F – goes home; 0 – cycles plunger; * - stops all motors; Shelf letter – moves cup to shelf selected; Column # - moves cup to column selected.
2	Port Test = A – opens port; B – closes port; C – sensor test ON; D – sensor test OFF; E – cup LED's on; F – port LED's on; * - All Stop.
3	Delivery (Picker) Cup Check = “On (status of cup sensor):#”; “In (detects product in cup):#”; “Out (picker out switch status):#”; “Hm (picker home switch status):#”.
4	Repeat Vend
5	Vend Error Codes = Factory Use Only / Do Not Use.
6	Product Sensors = All BevMax 4 5800-4 set ON
7	Factory Use Only / Do Not Use
8	Shelf Offset = BevMax 4 5800-4 Shelf Location “D2” = 700
9	(Not Used)
0	Hook Swipe X = sets far right travel distance to Delivery door (BevMax 4 5800-4 factory default = 93871).

****Test Vend** = Test Mode press “9” and “*” (enter) to get to “**Enter Selection**”. Close the service door and choose desired selection to test vend.

To set Timers for schools = Set Date/Time / Set Not Available blocks / Set Not Available Times / Set Daylight Savings Time

Cash and Sales Numbers = Sales / Number Sold / Sales by Column / Total Sales / Cash Box

*****Set Shelf Location** = Service Mode press “8” - BevMax 4 5800-4 = D2 – Domestic, E3 - Export 5 Shelf, E4 – Export 4 Shelf (default is 700)

Set Hook Swipe X = Test Mode press “F” and “*” (enter) to get to “**Factory Diagnostics**”. Press “8” and “*” (enter) to get to Hook Swipe ##### (default is 91871).

SERVICE MODE MENU ITEMS

Note: Menu items with the ** are not currently available.

SERVICE MODE

Enter SERVICE MODE by opening the service door and pressing the Service button once. The display will read "SERVICE MODE". The following choices are now available:

NEXT ITEM - Press key "A"

CASH BOX - Press key "B"

Shows the amount of change diverted to the cash box from the coin mechanism since the last CLEAR TOTALS or MASTER RESET. To view the cash box totals, press the letter "B" on the keypad and the display will show "CASH BOX", then press the "*" key and the display will show Cash Box \$#.##. Press the "CLR" key to return to "CASH BOX". Press the "CLR" key to return to "SERVICE MODE" or press the "A" key to advance to the next menu item below.

SALES (displayed if BevMax 4 5800-4 only) - Press key "C"

TOTAL SALES (displayed if BevMax 4 5800-4 with Snack Vender attached) - Press key "C"

Shows total sales since last CLEAR TOTALS or MASTER RESET. This total includes change not diverted to the cash box and still being held in coin mechanism escrow tubes. To view the total sales press the letter "C" on the keypad and the display will show 1 - "SALES" if BevMax 4 5800-4 only, then press the "*" key and the display will show Sales #.##. Press the "CLR" key to return to "SALES". Press the "CLR" key to return to "SERVICE MODE" or press the "A" key to advance to the next menu item below. 2 - "TOTAL SALES" IF BevMax 4 5800-4 with Snack Vender attached, then press the "*" key and the display will show "Drink Sales #.##". Press the "*" key and the display will change to "Snack Sales #.##". Press the "CLR" key to return to "SALES" or "TOTAL SALES". Press the "CLR" key to return to "SERVICE MODE" or press the "A" key to advance to the next menu item below.

DISPLAY TEMPERATURE - Press key "D"

Shows the cabinet temperature in degrees Celsius or degrees Fahrenheit. Press the letter "D" on the keypad. The display will show "Display Temperature". Press the "*" key and the display will show "Display: ON (or OFF) Press "** – turn OFF (or ON)". Press the * Key to toggle on/off or press the CLR Key to not change settings. If "on" is

selected the Display will change to "Set Temperature Unit Degrees F (or C) showing the current setting temperature will be displayed. Press F for Fahrenheit or C for Celsius. Press the * Key to save and return to "Display Temperature." Press the "CLR" key to return to "SERVICE MODE" or press the "A" key to advance to the next menu item below.

SET REFRIG TEMP – Press Key "E"

Allows the service technician to set the average product temperature (set point) for initial pull down and reload recovery. Press the letter "E" on the keypad and display will show "SET REFRIG TEMP". Press the "*" key on the keypad and the display will read "tt.tx" where x is Fahrenheit or Celsius and tt.t is the degrees. To change the set point press the key numbers you wish the set point to be (temperature set must be between 32° and 75° F or 0° and 23.8° C). Press the "*" key to save the new set point temperature and return to "SET REFRIG TEMP". Press the "CLR" key to return to "SERVICE MODE" or press the "A" key to advance to the next menu item below.

CLEAR TOTALS - Press key "F"

Allows the service technician to clear totals in CASH BOX, SALES, NUMBER SOLD, DOOR OPENINGS, POWER OUTAGES, SALES BY COLUMN, and all other interval data. Press the letter "F" on the keypad and the display will show "CLEAR TOTALS". Press the "*" key, the display will read Clear Interval Data? * = Y CLR = N. Press the "CLR" key to return to "Clear Totals" with out resetting the totals. Press the selection you wish to use and display will return to "Clear Totals". Press the "CLR" key to return to "SERVICE MODE" or press the "A" key to advance to the next menu item below.

NUMBER SOLD - Press key "1"

Shows the total number of items sold since the last CLEAR TOTALS OR MASTER RESET. Press the number "1" on the keypad and the display will show "NUMBER SOLD". Press the "*" key and the display will show "Number Sold #". Press the "CLR" key to return to "Number Sold". Press the "CLR" key to return to "SERVICE MODE" or press the "A" key to advance to the next menu item below.

ENABLE ITEM - Press key "2"

Allows an individual selection, a complete tray, or the entire machine to be enabled or disabled. This is most commonly used when a selection is out of order and you are awaiting parts and do not want the customer to utilize that selection. Press the number "2" on the keypad and the display will show "ENABLE ITEM". Press the "*" key and the display will read "Enter Selection". There are now three choices:

1. Pressing the “* ” key will toggle between enabled and disabled for the entire machine, the display will show the new state i.e. enabled or disabled and display will show “Blocked (Unblocked) Continue? * = Y CLR = N.
2. Pressing a tray selection followed by “* ” will show the new state of that tray. (For example, pressing “A* ” will show the new state for the A tray, the display will show the new state i.e. enabled or disabled and display will show “A Blocked (Unblocked) Continue? * = Y CLR = N.
3. Pressing an item selection will show the new state of that item; for example, pressing “A1” will show the new state of that item, the display will show the new state i.e. enabled or disabled and display will show “A1 Blocked (Unblocked) Continue? * = Y CLR = N.

If a selection has been disabled in this mode and the customer tries to purchase from the programmed selection(s), the vender will display “SELECT ANOTHER ITEM”. Press the CLR Key to show all items that are blocked or the * Key to disable more items. Press the “CLR” key to return to “Enable Item”. Press the “CLR” key to return to “SERVICE MODE” or press the “A” key to advance to the next menu item below.

SALES BY COLUMN - Press key “3”

Shows the total number sold from each selection since the last CLEAR TOTALS or MASTER RESET. Press the number “3” on the keypad and the display will show “SALES BY COLUMN”. Press the “* ” key and the display will read “Select Column”. Select the column to be checked (the total number sold from that selection will be on the right side of the display and the item number will be on the left side of the display). Press the “CLR” key to return to “Sales by Column”. Press the “CLR” key to return to “SERVICE MODE” or press the “A” key to advance to the next menu item below.

ESCROW - Press key “4”

Allows a bill to be returned if the change return lever is pressed before a selection is made. Factory setting is ESCROW OFF. Press the number “4” on the keypad and the display will read “ESCROW OFF” or “ESCROW ON”, depending on the current state. Pressing the “* ” key toggle the vender from ESCROW OFF to ESCROW ON. Example: If “ESCROW OFF” is showing on the display, pressing the “* ” key will disable the escrow function and the display will read ESCROW ON. This feature only affects those machines with a bill validator installed. Press the “CLR” key to return to “Escrow”. Press the “CLR” key to return to “SERVICE MODE” or press the “A” key to advance to the next menu item below.

FORCE VEND - Press key “5”

Forces the customer to make a vend by inhibiting the coin return lever once the minimum vend price line has been met or exceeded The coin return lever will not be inhibited if there is not enough credit to vend the lowest priced item or if a vend failure has occurred. Factory setting is “FORCE OFF”. Press the number “5” on the keypad the display will read “FORCE OFF” or “FORCE ON”, depending on the current state. Pressing the “* ” key will toggle the state. Press the “CLR” key to return to “Force Vend”. Press the “CLR” key to return to “SERVICE MODE” or press the “A” key to advance to the next menu item below.

SET TEMPERATURE SCALE- Press key “6”

Allows the service technician to change the scale of the temperature in the vender to read in Fahrenheit or Celsius as needed. Press the number “6” on the keypad and the display will show “Set Temperature”. Press the “* ” key and the display will show “Set Temperature Unit Degrees F (or C)”. Press the C to display in Celsius or F to display in Fahrenheit. Press * to save and display will return to “Set Temperature”. Press the “CLR” key to return to “SERVICE MODE” or press the “A” key to advance to the next menu item below.

SET PRICES – (Regular & Secondary)

Press key “7”

To set the prices enter the “SERVICE MODE” by opening the service door and pressing the Service Button once. Allows the setting of regular and secondary prices for an individual item, a complete tray, or the entire machine. Factory setting is \$99.95. Press the number “7” on the keypad and the display will show “SET PRICE”. Press the “* ” key and the display will show “1 = Regular Pricing, 2 = Secondary Pricing”. To set regular prices press number 1 key and display will show “Regular \$##.##”. To set price:

1. **All selections.** Press the keypad numbers of the price you wish to use. As numbers are entered the numbers will shift in from the right as they are entered. Note: The CLR key will remove the last # of the price. Once the desired price is showing on the display press the “* ” key and the display will show “PR\$##.## All Set”, press “* ” to enter more prices or CLR to exit to SET PRICE.
2. **One tray.** Press the keypad numbers of the price you wish to use. As numbers are entered the numbers will shift in from the right as they are entered. Note: The CLR key will remove the last # of the price. Once the desired price is showing on the display press the tray letter desired for setting price. Press “* ” and display will show “PR \$##.##

B(tray letter) Row Set”, press “*” to set more prices or CLR to exit to SET PRICE.

- 3. Single selection.** Press the keypad numbers of the price you wish to use. As numbers are entered the numbers will shift in from the right as they are entered. Note: The CLR key will remove the last # of the price. Once the desired price is showing on the display press the selection desired for setting price. Press “*” and display will show “PR ###.## B1 Selection Set”, press “*” to set more prices or CLR to exit to SET PRICE.

The last price entered for a selection is the one that is used. For example, if one price on the A tray was set to \$1.50 using option 3 above and you wish to change the remaining selections on that tray using option 2, the pricing for the entire tray would take precedence. Conversely, if the price was set using option 2 first followed by the single selection using option 3, the pricing for the remainder of the shelf would remain and the new price for the single selection would change to the new value. Press the “CLR” key to return to “Set Prices”. Press the “CLR” key to return to “SERVICE MODE” or press the “A” key to advance to the next menu item below.

SET SHELF LOCATION - Key “8”

Allows the service technician to program the electronics to match the seven different settings available for the shelves. These settings are available to vend different package heights. The factory default setting is Shelf Setting D. Press the number “8” on the keypad and display will show “Set Shelf Location”. Press the “*” key and display will show current setting. To change the setting press one of the following: A = G setting, B = M1 setting, C = M2 setting, D = D setting, E = E setting, F = E1 setting, 1 = D2 setting, 2 = E3 setting, & 3 = E4 setting. D2 = BM3 5800-4 domestic setting. Note G, M1, & M2 settings are used in venders prior to 0001-8487AE and D, E, & E1 settings are used in venders 0001-8487AE & higher, D2 is setting used in all domestic BevMax 4 5800-4 venders and E3 (5 shelf Export) & E4 (4 shelf Export) are used in export BevMax 4 5800-E4 venders. Once the desired setting is showing on the display press the “*” key to save the setting. Note: all shelf settings have to be physically set to match the programmed setting. You can not set the physical shelf settings differently. Press the “CLR” key to return to “Set Shelf Location”. Press the “CLR” key to return to “SERVICE MODE” or press the “A” key to advance to the next menu item below.

RELAY TOGGLE - Press key “9”

Allows the service technician to test the Light Relay, Fan Relay, and Compressor Relay. Press the number “9” on the keypad and the display will show “Relay Toggle”. Press the “*” Key and display will

show “Light A – On or Off”, “Fan B – On or Off”, “Compressor C – On or Off”. Display will show current status of the relay (not the component the relay operates). To toggle the state of a given relay press the letter key associated with it on the display. Caution: Disconnect power to the compressor before testing the compressor relay. Failure to disconnect power to the compressor before testing the relay could result in damaging the compressor. Press the “CLR” key to return to “Relay Toggle”. Press the “CLR” key to return to “SERVICE MODE” or press the “A” key to advance to the next menu item below.

CLEAR ERRORS - Press key “0”

Allows the service technician to clear errors recorded in the venders data. Press the number “0” Key and the display will show “CLEAR ERRORS”, then press “*” Key and the display will show “Clear All Errors? * = Y CLR = N”. Press the “CLR” key to return to “Clear Errors”. Press “*” Key to clear all errors or press the “CLR” key to return to “SERVICE MODE”.

TEST MODE

Enter TEST MODE by opening the service door and pressing the blue Service button twice. The display will read “TEST MODE”.

NEXT ITEM - Press key “A”

LIST ERRORS - Press key “B”

Allows the service technician to view a list of all recorded errors. Press the letter “B” on the keypad and the display will show “LIST ERRORS”, then change to “NONE” if no errors exist or, if errors are present, one of the error prompts below will be displayed. If an error code is displayed, press the “*” key to view the next error until “END LIST” is displayed. With “END LIST” showing on the display, press the “*” key to clear errors and return to TEST MODE. If you wish to exit the list without clearing errors, simply push the “CLR” key and the display will return to LIST ERRORS. If the CLR key is pressed prior to reaching the end of the list, the display will jump to END LIST. Explanations for the error codes are listed below. Note: The prompts listed will only show on the display if an error has occurred.

NONE No errors have occurred.

VEND MECH ERROR

HORIZ – Horizontal Drive System problem.

VERT – Vertical Drive System problem.

PICKI – Picker not all the way in problem.

PICKO – Picker out switch error problem.

PICKRS – Picker Return Spring

PORT – Port Drive System problem.

VS – Vend Sensor problem.

VMC ERRORS

FRAM – Memory module read/write error.
RTC – RTC read/write error, clock error.
SF – Decimal error.
RCRC – software not loaded properly.
LB – Low battery.
CTRL PWR OUT – Power lost.

KEYPAD ERROR

KEYPAD – Keypad not installed.

COIN MECH ERROR

CM CC – Coin Mech disconnected.
CM TS – Tube Sensor defective.
CM IC – No coin accepted for 96 hours (4 days).
CM TJXX – Tube jam.
CM CRCH – Check sum.
CM EE – Excessive escrow pressed (255 times between coin arrivals).
CM NJ – Coin jam.
CM LA – Low acceptance count.
CM DIS – Acceptor unplugged.
CM ROUT – Coin routing error.

NOTE ACCEPTOR ERROR

NA BC – Note Acceptor disconnected.
NA BFUL – Stacker full.
NA BILL – Defective motor.
NA BJ – Validator jammed.
NA BRCH – ROM checksum error.
NA BOPN – Stacker out of position.
NA BS – Sensor problem.

CARD READER ERROR

CRC – Card reader disconnected.

REFRIG ERROR

SENS – Temperature sensor problem.
COLD – Temperature to cold.
HOT – Temperature to hot.
CMPR – Compressor not cooling.
HEALTH – Health Guard error.

END LIST Indicates you have scrolled through the list of all present errors. Press the “CLR” key and display will change to “OK” and the display will change to “NONE”. Press the “CLR” key to return to “TEST MODE”, or the “A” key to proceed to “SELF TEST”

LIGHT TIMER - Press key “C”

Allows the service technician to set the 2 vertical lights to shut off for added energy savings after selected time recorded is met for no activity on the key pad or peripherals. Press the letter “C” on the key pad and display will show “Light Timer: ## hrs.” where ## is the current hour time recorded for meeting no activity to turn the two vertical lamps off. To change the hour(s) setting press the key pad numbers that you wish to set for no activity to be met for the lamps to shut off. Press the “*” key to save and the display will return to “Light Timer”. Press the “CLR” key to return to “TEST MODE”, or the “A” key to proceed to next available mode.

**** ENABLE SNACK MENUS** - Press key “D”

This sub menu is used to enable and disable the Satellite Snack menus. Press the “*” key to toggle the menu on or off.

KEYPAD TEST - Press key “E”

Allows the service technician to test any or all keypad keys. Press the letter “E” on the keypad and the display will show “KEYPAD TEST”. Press the “*” key and the display will show “Keypad Test”, then press each key on the keypad. Each key pressed will show on the display until the “CLR” key is pressed. The display will return to “Keypad Test”. Press the “CLR” key to return to “TEST MODE” or press the “A” key to advance to the next menu item below.

FACTORY DIAGNOSTICS - Press key “F”

Allows the service technician to test the XY and Cup port operations. The following are available in the test menu: 1 = Position Test, 2 = Port Test, 3 = Delivery Cup Check, 4 = Repeat Vend, 5 = Vend Error Codes, 6 = Product Sensors, 7 = Turns off vend mech for software test, 8 = Adjust shelf offset, 9 = Not used at this time, 0 = Adjust Hook Swipe “X” Offset, A = Software Build Number, E = Extended Cup Setting, F = Cup Sensor Setting. To enter the available modes press the “F” Key on the keypad and display will show “FACTORY DIAGNOSTICS”. Press the “*” key and the display will show “1 = Position Test, 2 = Port Test”. Press the key # or letter you wish to enter. Note: In early software revisions Port Test was 4, Repeat Test was 2, & Shelf Offset was 8. Below is current programming as of 3/26/08.

- **Key A** = Build Number #####. Press key A and the display will show “Build Number #####”. Where ##### is the software build number significant to Crane Merchandising Systems engineering. Press the “CLR” Key to return to “Factory Diagnostics”.
- **Key B** = Reset Model Number. Press key B and the display will show “Reset Model? Continue? * = Yes CLR = No”. Press the * key and display will show “No Model Set Save? A = ^ (scroll up) * = Yes CLR = No”. Press key A to scroll through available model numbers DN5800-4, DN3800-4, DN5800-E4 (export), DN3800-E4 (export). With vender model displayed that you are installing board press the * key to save. Press the “CLR” Key to return to “Factory Diagnostics”.
- **Key E** = Extended Cup. Press key E and the display will show “Extended Cup: Enabled”. Press the “*” key to toggle the Extended Cup to the Disabled setting. Factory default setting is Enabled. Note Extended Cup Disabled setting is used in BevMax 2 Pepsi Venders prior to

8625CF and Generic Venders prior to 8600AG. Extended Cup Enabled is used in all BevMax 4 5800-4 Venders.

- **Key F** = Cup Sensor. Press key F and the display will show “Cup Sensor Off”. Press the “*” key to toggle the Extended Cup to the On setting. Cup Sensor On is used in all BevMax 4 5800-4 Venders produced 3/26/08 and after.
- **Key 1** = Position Test. Note: The left or top door switch (depending on the mounting bracket in use) must be pulled to the out position to perform this test. **Caution: XY needs to be in the home position before performing this test.** If you look at the control board the green, amber (yellow), and red lights should be on at this time. If not please check the following: Green light is for home switch on bottom of port cup, amber light is for home switch on left side of Y motor assembly, red light is for home switch for picker cup plunger. Press the number 1 key and the display will show a set of numbers (ie ##### # ##### #). To position test press the following:
 - a. Shelf letter (A,B,C,D,E) to travel to selected shelf.
 - b. Column number (1,2,3,4,5,6,7,8, & 9) to travel to selected column.
 - c. Key “0” to cycle cup plunger to hit column target.
 - d. Key “F” to return cup to home position.
 - e. Key “*” is all stop.
- **Key 2** = Port Test. Press the number 2 key and the display will show four numbers “####”. The 1st # is Port Open switch and 0 = Port not open or 1 = Port opened. The 2nd # is Port Closed switch and 0 = Port not closed or 1 Port closed. The 3rd # is Sensor and 1 = Sensor on or 0 = Sensor off. The 4th # is Vend detect (only if Sensor is on) 0 = No product in port or 1 Product in port. To test the port press the following:
 - f. Key “A” to open port.
 - g. Key “B” to close port.
 - h. Key “C” to turn sensor on. When turned on and something is placed in the port a red LED will light on the board.
 - i. Key “D” to turn sensor off.
 - j. Key “E” to toggle Cup LED light.
 - k. Key “F” to toggle Port LED light.
 - l. Key “*” All Stop on any of these tests.
- **Key 3** = Delivery Cup Check. Press the number 3 key and the display will show “On:0 In:0 Out:0 Hm:1”. Note: The door switch (or left door switch on e-lock venders) must be pulled to the out position to perform this test. **Caution: XY needs to be in the home position before**

performing this test. Press the “*” key and the display will show “Port Sensor On/Off On:0 In:0 Out:0 Hm:1”. Press the “*” key to toggle the Port Sensor to the Off setting. To test the Port with the Port Sensor On, press the “*” key and Display will show “Port Sensor On - On:1 In:0 Out:0 Hm:1”. To perform tests press the following:

- a. Shelf letter (A,B,C,D,E) to travel to selected shelf.
- b. Column number (1,2,3,4,5,6,7,8, & 9) to travel to selected column.
- c. Key “0” to cycle cup plunger to hit column target. The Out:0 will change to 1 momentarily and back to 0 and the Hm:1 will change to 0 momentarily and back to 1.
- d. Key “F” to return cup to home position.
- e. If the delivery cup has a cup sensor in it, place a package in the delivery cup and the In:0 will change to In:1, remove package and it will change to In:0.

There are 4 pieces of data shown on the display labeled as “On”, “In”, “Out”, and “Hm”.

“On” indicates whether the delivery cup sensor if present is turned on or off. A “1” indicates it is on and a “0” indicates it is off.

“In” indicates whether the delivery cup sensor detects product in the cup. In order to be detected the product must be placed in the cup after the sensor was turned on. If a product is in the cup when the sensor is turned on, the sensor will not detect it. A “1” indicates product is detected and a “0” indicates it is not. When the sensor is turned off, there will be a “0” regardless of whether product is in the cup or not. The Yellow LED on the controller also will be on when a “1” is displayed.

“Out” indicates whether the picker out switch is closed. A “1” indicates that the picker out switch is closed and a “0” indicates it is opened (plunger at home position). Please note that the switch is moved by the cam, not the picker. Pulling the picker out by hand will not

activate the switch. The cam position is what activates the switch. The motor must actually drive the picker out and it must be all the way out in order for the switch to detect it is out. The Green LED on the controller also will be on when a “1” is displayed.

“Hm” indicates whether the picker home switch is closed. A “1” indicates that the picker home switch is closed (plunger at home position) and a “0” indicates it is opened. This switch is moved by the plunger, pulling the plunger out by hand will turn the switch off. The Red LED on the controller will also be on when a “1” is displayed.

- **Key 4** = Repeat Vend. Press the number 4 key and the display will show “Current Vend: #####” and start auto test vending each column. Press the “CLR” key to stop the test
- **Key 5** = Vend Error Codes – Caution: Factory Use Only do not use.
- **Key 6** = Product Sensors. Press key 6 and the display will show “Product Sensors On”. Press the “*” key to toggle the Product Sensors to the Off setting. Factory default setting is on. Note Product Sensors Off setting is used in BevMax 2 Pepsi Venders prior to 8625CF and Generic Venders prior to 8600AG. Product Sensors On is used in all BevMax 4 5800-4 Venders.
- **Key 7** = Turns off vend mech for software test. **Caution: Factory use only for peripheral testing, do not use.**
- **Key 8** = Adjust Shelf (Y) Offset (up and down). Press the number 8 key and the display will show “Shelf Offset #####, 3310 counts = 1 inch”. To change the offset enter a new number and press the “*” key to save and display will show “#### Offset recorded. Then press “CLR to go back to “Factory Diagnostics”. Go back to Position Test and check the plunger is contacting the targets correctly.
- **Key 9** = Not used at this time.
- **Key 0** = Adjust Hook Swipe “X” Offset (left to right). Press the number “0” key and the display will show “Hook Swipe #####, 3310 counts = 1 inch”. For factory default setting see born on label settings listed on service door. To change the off set, pull the top left (white) door switch in the out position to power the XY motors. Press the “*” key once will automatically run the Delivery Cup Assembly to the swipe position and allow specific vender coordinates to be changed and saved in the control board memory. Use the numbers on the key pad to change the coordinates. Press the “*” key to

save the new setting and the Delivery Cup Assy. will automatically go to the “Home” position, then move back to the swipe position again. Press the “*” key to send the Delivery Cup Assy. back to the “Home” position and the programming will return to “Factory Diagnostics”. Press “CLR” key to return to “Test Mode”. Then go to “Test Vend” and test for proper delivery of product in the Port Assy. of the Service Door.

Press the “CLR” key to return to “Factory Diagnostics”. Press the “CLR” key to return to “TEST MODE” or press the “A” key to advance to the next menu item below.

TUBE FILL/DISPENSE - Press key “1”

Allows the service technician to inventory currency in the coin mechanism escrow tubes and “Teach” the controller how many coins of each denomination are in that inventory. This allows for the maximum number of dollar bills to be accepted prior to enabling the “USE EXACT CHANGE” function. This also provides for exact cash accountability in the audit functions. This function can also be used as a diagnostic tool to insure the coin mechanism is responding properly. Press the number “1” on the keypad and the display will read ‘TUBEFILL/DISPENSE’. Press the “*” key and the display will show the lowest denomination accepted and the number of these coins inventoried. Press the letter “A” on the keypad to show through the denominations available. With a given denomination displayed, an inserted coin of this denomination via the coin chute will increase the inventory shown. Note: When you insert any denomination the display will change to show the denomination inserted. To dispense: while in the tube fill/dispense mode go to the coin mech and press the coin mech dispense button(s) for the tube you wish to dispense from or press the * Key and the denomination displayed will be dispensed to the coin cup and the inventory will be decreased. Press the “*” Key again to stop the coins from being dispensed. Press the “CLR” key to return to “Tube Fill/Dispense”. Press the “CLR” key to return to “TEST MODE” or press the “A” key to advance to the next menu item below.

DAYLIGHT SAVINGS TIME - Press key “2”

Allows the service technician to enable daylight savings time to be set as it applies to the selected Daylight Savings Rules Setting. Press the “*” key to show the current setting. Press the “A” key to scroll through the different settings that are available. With the setting you wish to use showing on the display, press the “*” key.

- OFF – No Daylight Savings Time
- American Rules. If enabled, the VCU will set the clock back one hour on the last Sunday of October (2:00 AM), set the clock ahead one hour on the first Sunday in April (2:00 AM).

- European Rules. If enabled, the VCU will set the clock back one hour on the last Sunday of October (1:00 AM), set the clock ahead one hour on the last Sunday in March (1:00 AM).
- Australian Rules. If enabled, the VCU will set the clock back one hour on the last Sunday of March (1:00 AM), set the clock ahead one hour on the first Sunday in October (1:00 AM).

Press the “CLR” key to return to “Daylight Savings Time”. Press the “CLR” key to return to “TEST MODE” or press the “A” key to advance to the next menu item below.

NOT AVAILABLE MODE - Press key “3”

This setting works in conjunction with the “SET NOT AVAILABLE TIME” (option 3 in Setup Mode 1). This setting must be showing “Not Available # On” in order for the Not Available times to function as programmed. This mode can also be used to manually disable the times established in ‘NOT AVAILABLE TIME’ mode as long as the function is set to “Not Available # Off”. Press the number “3” on the keypad and the display will show “NOT AVAILABLE MODE”. Press the * Key and display will show “Select Block (1 – 4). Press the select block group you wish to enter. Display will show “Not Available #: On (Off) Press * turn off (on) to change the status. Factory default for this setting is Off. Pressing the “*” key will toggle the state and set the controller to the new condition shown on the display (pushing the “*” key with ON on the display will ALLOW the not available mode to function as programmed). Press the “CLR” key to return to “Not Available Mode”. Press the “CLR” key to return to “TEST MODE” or press the “A” key to advance to the next menu item below.

CREDIT TIMER MODE - Press key “4”

Allows the service technician to set the vender to cancel a credit or keep a credit showing on the display after 5 minutes. Press the number “4” on the keypad and the display will show “CREDIT TIMER MODE”. Press the “*” Key and the display will show “Credit Timer: Off (On) Press “*” - turn On (Off). “Credit Timer Off” will save a credit indefinitely. “Credit Timer On” will only save a credit for five minutes. Press the “CLR” key to return to “Credit Timer Mode”. Press the “CLR” key to return to “TEST MODE” or press the “A” key to advance to the next menu item below.

DOOR OPEN - Press key “5”

Shows number of times the service door has been opened since last “CLEAR TOTALS” or “MASTER RESET”. Press the number “5” on the keypad and “DOOR OPEN” will show on the display. Press the “*” Key and “Door Opened # Times ###:## ## Month

YEAR” will show on display. This is the number of times the service door has been opened since the last “CLEAR TOTALS” or “MASTER RESET” and the time, day, and date of the last opening. Press Key “A” to see the time of the 5 previous openings. Press the “CLR” key to return to “Door Open”. Press the “CLR” key to return to “TEST MODE” or press the “A” key to advance to the next menu item below.

POWER OUT - Press key “6”

Shows the number of times the machine has lost power since last “CLEAR TOTALS” or “MASTER RESET”. (This is a power outage for any reason including the machine being unplugged or the machine’s master power switch being turned off). Press the number “6” on the keypad and “POWER OUT” will show on the display, press the “*” Key and “Power Lost # Times will show on the display and the date and time of the last outage which is the number of times power has been lost to the control board since the last “CLEAR TOTALS” or “MASTER RESET”. Press Key “A” to see the time of the 5 previous outages Press the “CLR” key to return to “Power Out”. Press the “CLR” key to return to “TEST MODE” or press the “A” key to advance to the next menu item below.

TEST HEALTH GUARD - Press key “7”

This setting is in place to test the functioning of the health guard system by simulating a Health Code Error. Once activated, any selections programmed in “HEALTH CONTROL MODE” in the Setup Mode 1 will be disabled. To test health guard, press the number 7 on the keypad and the display will show “TEST HEALTH GUARD”. Push the “*” key and the display will change to “Test Health Guard? * = Y CLR = N. Press “*” and display will show Health Guard” then change to “Activated”. The display will then return to “TEST HEALTH GUARD”. Within one minute of returning the vender to service, items that were turned on in “HEALTH CONTROL MODE” setting in SETUP MODE 1 will be put out of service. Additionally, a “HEALTH” error will be displayed in ‘LIST ERRORS’. Errors must be cleared before programmed items can be returned to service. Press the “CLR” key to return to “Test Health Guard”. Press the “CLR” key to return to “TEST MODE” or press the “A” key to advance to the next menu item below.

DISPLAY HEALTH GUARD - Press key “8”

Allows the service technician to view the selections that are listed under the “HEALTH CONTROL MODE” in the SETUP MODE 1. Press the number “8” on the keypad and the display will read “DISPLAY HEALTH GUARD”. Press the “*” key and the selection(s) that are listed under the health control will be displayed or “NONE ASSIGNED” if no selections are listed. Press the “*” key to continue.

Press the “CLR” key to return to “Display Health Guard”. Press the “CLR” key to return to “TEST MODE” or press the “A” key to advance to the next menu item below.

TEST VEND - Press key “9”

Allows the service technician to test vend any item. The service door must be closed or open all the way so the discharge door does not hit the delivery cup during the test vend process. You will need to catch the product if you test with door open. Press the number “9” on the keypad and the display will read “TEST VEND”. Pull the top door switch in service door area to the out position for this test to work. Press the “*” key and the display will read “ENTER SELECTION”, you must close and lock door at this point if you wish to test with door closed. Select the item/column to be tested by pressing the corresponding keys on the keypad (i.e. A6), then press the “*” Key to start the test vend, and the corresponding vend cycle will occur. Press the “CLR” key to return to “Test Vend”. Press the “CLR” key to return to “TEST MODE” or press the “A” key to advance to the next menu item below.

SHOW CHECKSUMS - Press key “0”

This function is used by Factory Engineers only.

SETUP MODE 1

Enter SETUP MODE 1 by opening service door and pressing the Service button three times. The display will read “SETUP MODE 1”. NOTE: Several areas in SETUP MODE 1 are password protected. When entry into one of these areas is attempted the display will read “Password” if a password has been entered in SETUP MODE 1. The password must be entered at this point before the service technician is allowed to proceed. The password need only be entered once during a service call provided the service door is not closed. If the door is closed and then re-opened, the password must be entered again before accessing a protected area. The factory default password is 0000. If the password is set at 0000 you will not be required to enter a password to access password protected modes. The display will show “*’s” as the password is entered. When the last character is entered, the display will read “OK”, and then will shift into the requested area. If the display reads “BAD” after the last character is entered this means the password was not accepted.

NEXT ITEM - Press key “A”

ENTER MESSAGE - Press key “B”

(PASSWORD REQUIRED)

Allows the entry of a custom idle message to replace the default idle message. Press the letter “B” on the

keypad and “ENTER MESSAGE” will show on the display. Press the “*” key and “Edit Idle Message Enjoy a Refreshing Drink” will show on display with the first character on the left highlighted. The program is now ready to accept the new message. The “A” key will move forward through the alphabet, numbers, space, punctuation marks, \$, AND an “L”. The “B” key will move backwards through the same list. When the desired character is displayed, press the “*” key. That character is now entered and the display moves to the right one space as the new message is built. Press “*” with the curser showing “{” and the curser will back up one space. Press the “*” Key with the curser showing “|” will clear all characters to the right of the curser. When the new message is complete, press the “CLR” key and return to “Enter Message”. Press the “CLR” key to return to “SETUP MODE 1” or press the “A” key to advance to the next menu item below.

CLEAR MESSAGE - Press key “C”

(PASSWORD REQUIRED)

Allows the service technician to clear any custom idle message and return to the default idle message. Press the letter “C” on the keypad and the display will show “CLEAR MESSAGE”. Press the “*” key and the display will read “Clear Message? * = Y CLR = N, pressing the * Key will set idle message back to factory default and then will return to “Clear Message”. Press the “CLR” key to return to “SETUP MODE 1” or press the “A” key to advance to the next menu item below.

ENABLE/DISABLE \$ - Press key “D”

(PASSWORD REQUIRED)

Allows the service technician to remove the dollar sign (\$) from the display when a product price, customer credit, or change due is displayed. When enabled, the dollar sign will appear in the display; when disabled it will not appear. Press the letter “D” on the keypad; the display will show “ENABLE/DISABLE \$”. Press the “*” key and display will show “Dollar Sign: On (Off) Press “*” - turn Off (On). Press the “*” Key to toggle. Press the “CLR Key to return to “Enable/Disable \$”. Press the “CLR” key to return to “SETUP MODE 1” or press the “A” key to advance to the next menu item below.

SET HAPPY HOUR TIME - Press key “E”

(PASSWORD REQUIRED)

Allows the service technician to set times and days for Happy Hour operation. Press the letter “E” key and “SET HAPPY HOUR TIME” will show on the display. Press the “*” Key again and Happy Hour start time, end time, and days of the week can now be programmed into the system. All times must be entered in military time format (24 hour clock). Setting Happy Hour is covered in detail in the “SET

NOT AVAIL TIME” in the INITIAL PROGRAMMING section of this manual. Press the “CLR” key to return to “SETUP MODE 1”.

MASTER RESET - Press key “F”

(PASSWORD REQUIRED)

Allows the service technician to restore factory defaults to the machine or reset the Controller Board’s memory after installing a new EPROM. Since this feature resets interval sales data, care should be taken prior to using. Press the letter “F” on the keypad and “MASTER RESET” will show on the display. Press the “*” key and the display will read “Master Reset Continue? * = Y CLR = N. To reset press the “*” Key and display will show “Resetting” then show software version and then the idle message will scroll. Press the “CLR Key to return to “Master Reset”. Press the “CLR” key to return to “SETUP MODE 1” or press the “A” key to advance to the next menu item below. Please see table on next page for programming options effected by MASTER RESET. NOTE: A power out error message will be generated when a master reset is performed. The table outlines the results of using MASTER RESET.

ITEM	RESET TO
CASH BOX	\$0.00
SALES	\$0.00
NUMBER SOLD	0
SALES PER COLUMN	0
ESCROW	OFF
FORCE	OFF
SET REGULAR PRICES	99.95
SET HAPPY HOUR PRICES	99.95
LIST ERRORS	Pwr Out
TUBE FILL/DISPENSE	CLEARED
DAYLIGHT SAVINGS	OFF
NOT AVAILABLE	OFF
CREDIT TIMER	OFF
DOOR OPEN	0
POWER OUT	1
IDLE MESSAGE	RESET
ENABLE DOLLAR SIGN	ON
MACHINE NUMBER	UNCHANGED
SET HAPPY HOUR	CLEARED
NOT AVAILABLE TIME	CLEARED
HEALTH CONTROL	OFF
PASSWORD	0000
STS ENABLE	OFF
CUSTOM STS	CLEARED
NOVEND LIMIT	0
SOLD OUT	ENABLED
PRICE DISPLAY	ON
SHELF CONFIG	G
INTERVAL CLEARING	OFF
DISPLAY TEMPERATURE	ON
TEMPERATURE UNITS	DEG F
SERIAL #	UNCHANGED

LOCATION ID	UNCHANGED
CR ASSET #	UNCHANGED
NA ASSET #	UNCHANGED
CM ASSET #	UNCHANGED
SOLD OUT TIMES	CLEARED
DEX PASSWORD	000000
DOOR OPEN TIME	CLEARED
POWER OUT TIME	CURRENT TIME
STORAGE TEMP	57° F (13.8° C)
REFRIG TEMP	37° F (2.7° C)
CONSUMER OVERPAY	OFF

MACHINE NUMBER - Press key “1”

(PASSWORD REQUIRED)

Allows assigning a user number to the machine for audit and/or inventory control requirements. Press the number “1” on the keypad and “MACHINE NUMBER” will show across the display and then change to the number currently assigned to the machine (i.e. ID 1). Press the “*” key and the display will read “ID”. Enter the new number (numeric field, 4 characters maximum). If the new number is less than 4 characters press the “*” key after entering it and the display will read “OK” momentarily and will return to “SETUP MODE”. Press the “CLR Key to return to “Machine Number”. Press the “CLR” key to return to “SETUP MODE 1” or press the “A” key to advance to the next menu item below.

SET HAPPY HOUR - Press key “2”

(PASSWORD REQUIRED)

Allows the service technician to turn Happy Hour ON or OFF. Press the number “2” on the keypad and “SET HAPPY HOUR” will show across the display. Happy Hour. Press the * Key and display will show “Happy Hour: Off (On). Press “*” - turn On (Off). Press the “CLR Key to return to “Set Happy Hour”. Press the “CLR” key to return to “SETUP MODE 1” or press the “A” key to advance to the next menu item below.

SET NOT AVAIL TIME - Press key “3”

(PASSWORD REQUIRED)

Password protected. Before entering or changing this setting you must enter the password if one has been assigned. This mode allows up to 4 different time periods that use of the machine may be restricted. Refer to Initial Set Up section Set Not Available Times on page 12.

CONSUMER OVERPAY - Press key “4”

(PASSWORD REQUIRED)

Allows the service technician to set the machine up to allow consumer overpay to vend. This will allow a vend if there is not enough change in the mech to be paid to consumer. Factory default will be Off. Press the number “4” key and display will show “Consumer Overpay”. Press “*” Key and display will show

“CONSUMER OVERPAY OFF (ON), Press “*” - turn ON (OFF)” will show on the display. Press the “*” Key to toggle setting and press CLR return to “Consumer Overpay”. Press the “CLR” key to return to “SETUP MODE 1” or press the “A” key to advance to the next menu item below.

DATE/TIME - Press key “5”

Shows the year, month, date, and time setting currently in the system in following format: 2005 Apr 28 15:45. Setting the day, date, and time is covered in the INITIAL PROGRAMMING section of this manual. Press the “CLR” key to return to “SETUP MODE 1”.

TOTAL SALES - Press key “6”

Shows total sales since machine manufacture. This total is not cleared by CLEAR TOTALS. Press the number “6” on the keypad, the display will show “TOTAL SALES” press the “*” Key and “Sales: ### and Vend ### totals will show on display. Press the “CLR” key to return to “Total Sales”. Press the “CLR” key to return to “SETUP MODE 1” or press the “A” key to advance to the next menu item below.

HEALTH CONTROL - Press key “7”

Allows the service technician to select items to ENABLE HEALTH CONTROL. When enabled, if the temperature in the vender does not reach 41° F (5° C) within 30 minutes after the service door is closed, a “HEALTH TIME” error will occur and lockout the enabled selection(s) from vending until after the error is cleared. Also, if the temperature in the vender goes above 41° F (5° C) for more than 15 minutes after the initial cool down period, a “HEALTH CONTROL” error will occur and lockout the enabled selection(s) from vending until the error is cleared. Press the number “7” on the keypad and the display will show “HEALTH CONTROL”. Press the “*” key and the display will show ‘ENTER SELECTION’. To set:

1. **All selections.** Press the “*” key and display will show “Disabled (Enabled) Continue? * = Y CLR = N. When enabled all selections in the vender will now be set for health control. Press CLR to show all selections assigned. Then press CLR and the display will change to “ENTER SELECTION”. Press CLR to return to “HEALTH CONTROL”.
2. **One tray.** Pressing the letter of the shelf followed by the “*” key and display will show “Disabled (Enabled) Continue? * = Y CLR = N. When enabled all selections on that shelf will now be set for health control. For example, to control the A shelf push key “A” followed by “*” key. The display will change to “ENTER SELECTION”. Press CLR to display all selections assigned then

press CLR to return to “HEALTH CONTROL”.

3. **Single selection.** Pressing the desired selection followed by the “*” key and display will show “Disabled (Enabled) Continue? * = Y CLR = N. When enabled desired selection will now be set for health control. For example, to control the A1 push keys “A1” followed by “*” key. The display will show “Disabled (Enabled)” etc... Press CLR to display all selections assigned then press CLR to return to “HEALTH CONTROL”.

Priority will be given to the higher ranked method. If one selection on the A tray was set to ENABLE using option 3 above and you wish to change the remaining selections on that tray using option 2, the Setting for the entire tray would take precedence. Conversely, if the tray was set using option 2 first followed by the single selection using option 3, the setting for the remainder of the shelf would remain and the new price for the single selection would change to the new value. Press “CLR” to return to “SETUP MODE”.

UPDATE SOFTWARE - Press key “8”

(PASSWORD REQUIRED)

Allows the service technician to manually load software if needed. New software automatically loads on power up. **Caution:** If this mode is entered with no EPROM installed in controller, it will cause control board failure. The following information describes how to update software. All new software revisions will automatically update the software revision in the control board. **Important:** EPROM’s containing software are sensitive to Electrostatic Discharge (ESD). Failure to handle the Eprom carefully could cause damage, which may result in a failed control board. **ALWAYS KEEP THE EPROM IN THE ESD TUBE. GROUND YOURSELF ON THE VENDER CABINET BEFORE REMOVING THE EPROM FROM THE ESD TUBE OR CONTROL BOARD. AN EPROM CAN BE USED TO PROGRAM MANY VENDERS, AS LONG AS CARE IS TAKEN NOT TO DAMAGE THE EPROMS LEGS. ALWAYS TURN POWER OFF BEFORE REMOVING OR INSTALLING EPROMS IN THE CONTROL BOARD.** Important Notes: Use the programming section of the manual to program the vender.

2. EPROM Removal:
 - a. Power down the Vender. Ground yourself on the vender cabinet before removing the EPROM from the ESD tube or control board.
 - b. If an Eprom is present in the control board, remove the existing Eprom.
 - i. Note; An Eprom does not need to be in the control

board after the control board has been programmed. The Eprom can be used to program other boards.

- c. Verify the pins of the new Eprom are not bent before installing in the Eprom socket.
 - d. Install the new Eprom in the Eprom socket. Ensure the Eprom is oriented correctly with its reference marker (locator) in the same direction as the reference marker (locator) of the Eprom socket. Do not rely on the Eprom label for orientating the Eprom.
3. Automatic Reprogramming:
- a. Turn power on to Vender. When auto-updating the display will show old version for a few seconds while the red LED on the control board blinks.
 - b. Display will change to "EPROM UPGRADE..." for approximately 10 seconds with the green LED rapidly blinking.
 - c. Display will change to new version software with red LED blinking at a steady heart beat rate.
4. Manual Reprogramming (used if Eprom does not automatically reprogram):
- a. At power up, the current software version will be displayed. To manually program the control board with the new software, press the service switch on the control board to enter service menus. Advance to "UPDATE SOFTWARE". Press the "*" Key. Display will show "Reprogramming Vendor" while the yellow LED blinks.
 - b. Display will show new software revision, then return to stand by. This confirms new software has been successfully updated.

Note: to remove the Eprom after programming, remove power to the vender, ground yourself on the vender cabinet before removing the Eprom, remove the Eprom, while still grounded install a label on the microprocessor showing the revision of software that is installed in the controller, power the vender back on and test for proper operation.

SET LIGHTS OFF TIME - Press key "9"

Allows the service technician to set times and days for Light operation. Press the number "9" key and "SET LIGHTS OFF TIME" will show across the display. Lights Off start time, end time, and days of the week can now be programmed into the system. All times must be entered in military time format (24

hour clock). Set Lights Off Time can be set the same way as Set Not Available Time in the Initial Programming section of the manual.

ENTER NEW PASSWORD - Press key "0"

(PASSWORD REQUIRED)

Allows the service technician to enter a 4 number personalized password. IF YOU DECIDE TO CHANGE FROM THE DEFAULT PASSWORD, PLEASE ENTER THE NEW FOUR NUMBER PASSWORD SLOWLY AND CAREFULLY!!! Press the number "0" on the keypad and "ENTER PASSWORD" will show across the display. Press the "*" key and the display will read "ENTER PASSWORD". Enter the new password, the display will show * for each character Key pressed. Once new password is complete press "*" Key to save. Display will show "Verify new password", press new password, then the "*" Key. Display will show "Password recorded Continue? * = Y CLR = N. Press the "CLR Key to return to "ENTER NEW PASSWORD". Press the "CLR" key to return to "SETUP MODE 1" or press the "A" key to advance to the next menu item below.

SETUP MODE 2

Enter SETUP MODE 2 by opening the main door and pushing the Service button four times. The display will read "SETUP MODE 2"

NEXT ITEM - Press key "A"

STS ENABLE/DISABLE - Press key "B"

Turns Space-to-Sales Mode On and Off. When On, Space-to-Sales vends are performed according to the configurations defined using "DEFAULT STS" and/or "CUSTOM STS". Press the Letter "B" on the keypad. The display will show the current state of the Space-to Sales vend mode as "STS ON" OR "STS OFF". Press the "*" Key, there are now two choices:

1. Press the "CLR" key to leave the Space-to-Sales vend mode unchanged and return to "SETUP MODE 2"
2. Press the "*" key to toggle the state on or off. The display will show a new message indicating the updated state.

Press the "CLR Key to return to "STS ENABLE". Press the "CLR" key to return to "SETUP MODE 2" or press the "A" key to advance to the next menu item below.

CUSTOM STS - Press key "C"

Configures the Vender Space-to-Sales according to what is set. Press the letter "C" on the keypad. The display will show "Custom STS". Press the "*" Key and display will show "Enter Start Location".

1. Pressing the “*” key will set STS to a one to one configuration such that each selection is mapped only to its corresponding column.
Note: This setting overrides any previously defined Space-to-Sales blocks.
2. Pressing a tray selection followed by “*” will configure an entire tray as a single Space-to-Sales block. Example is selections A1 through A9 vend from columns A1 through A9 sequentially.
3. Pressing an item selection (A1) will specify the first product of the Space-to-Sales block. After the first item is programmed, the display will change to “Enter end location”. Press the item selection corresponding to the last item in the block. This option may transcend more than one shelf, i.e. A1 to B9.

In all of the above options, after a selection is made, Display will show “OK? * = Y CLR = N. You must press “*” at this prompt to save your setting. Press “CLR” at any time to return to SETUP MODE 2.

DEFAULT STS - Press key “D”

Configures the Vender Space-to-Sales to the preset mappings. Press “D” on the keypad and the display will show “DEFAULT STS”. Press the “*” key to configure Space-to-Sales in preset blocks of three (A1 – A3, A4-A6, A7-A9, B1-B3,...). Display will show “Set Default STS? * = Y CLR = N. You must press * at this prompt to accept Default STS. Press “CLR” at any time to return to SETUP MODE 2.

DISPLAY STS - Press key “E”

Allows verification of the Vender Space-to-Sales settings for an individual selection block. Press the letter “E” on the keypad. The display will show “DISPLAY STS”. Press the “*” key and the display will change to “ENTER SELECTION”. Enter any selection item, press the “*” Key, and the display will read “##-## ## Continue? * = Y CLR = N. The first ## indicates the first column in the selection’s block. The second ## indicates the last column in the selection’s block. The last ## indicates the column that the next vend will come from in this STS block. For example, entering “A2” might display “A1-A3 A1, indicating that selection A2 is part of the block that spans between A1 and A3 and that A1 selection is next in line to be vended. Press “CLR” at any time to return to SETUP MODE 2.

SET NOVEND LIMIT – Press Key “F”

If a Vend fails - either due to a vend error or no product detected in the recovery unit - and the drop sensor is enabled, the VMC will mark the column as sold out. If the Space-to-Sales is enabled, the product column will be removed from the Space-to-Sales rotation and the VMC will attempt to vend from

the next column in the Space-to-Sales block. If the vender is unable to vend any products from a Space-to-Sales block, the customer’s credit will be returned and the entire block will be marked as “SOLD OUT”. Press the “F” key on the keypad. The display will show “SET NOVEND LIMIT”. Press the “*” key and the display will show “NOVEND LIMIT #”. The value # is the current vend limit which is applied to each selection. When # is 0, no vend limits are enforced. Enter the desired vend limit and press the “*” key to accept this value or press the “CLR” key to cancel changes and return to SETUP MODE 2. The NOVEND limit specifies the number of times a location can be vended empty before it is blocked as “Sold Out”.

****MULTIVEND - Press key “1”**

This function, when turned on, allows credit to be retained after a vend so the customer can vend from another selection. (i.e. .50 vend price, put in \$1.00, push a select button and vends, .50 still shows on the display, push a second select button and vends). Credit is cancelled after 5 minutes of inactivity. There is unlimited acceptance. If a customer wants their credit (money) back, the coin return lever must be pressed. To show the current “Multi Vend” condition, press the “*”key and the display will show the current setting. Press the “*” key to toggle “Multi Vend” on and off.

SET LANGUAGE - Press key “2”

This function is used to set the language that will be used for sales mode messages. To display the current language selected, press the “*”key. To change the language selected, with the current setting displayed, press the “*”key to scroll through the available languages in the menu (English, French, German, Spanish, & Italian). Once the desired language is shown on the display, press the “*”key to save and return to Set Language.

SOLD OUT ENABLED/DISABLED - Press key “3”

Controls sold out detection by the port sensor. When “On”, a signal is sent to the VCU when the port sensor does not detect a selected item. That signal tells the VCU that the item selected is sold out and removes it from the STS block until the next time the vender is serviced. Press the number “3” on the keypad. The display will show “SOLD OUT ENABLED (DISABLED)”. Press the “*” key and display will show “Use Port Sensor: Off (On), Press “*” - turn On (Off). Press “CLR” to exit without making changes and return to “SOLD OUT ENABLE/DISABLE”. Press “CLR” to return to “SETUP MODE 2”.

PRICE DISPLAY - Key "4"

This setting controls whether the vender displays a price when a selection is made. Machines with a card reader capable of displaying selection prices may be configured to prevent displaying prices on two separate displays. Press the number "4" on the keypad and display will show "Price Display". Press the "*" Key and display will show "Price Display: On (Off)". Press "*" - turn Off (On). Press the "*" Key to toggle or press the "CLR" key to exit without making changes and return to "PRICE DISPLAY". Press "CLR" to return to "SETUP MODE 2".

STORAGE TEMP ENABLE/DISABLE -

Press key "5"

Press key 5 and display will show current state "Storage Temp Enable (Disable)". Press "*" Key and display will show "Storage Temp On (Off)". Press "*" - turn Off (On). Press the * Key to toggle or press the "CLR" key to exit without making changes and return to "STORAGE TEMP ENABLE/DISABLE". Press "CLR" to return to "SETUP MODE 2".

INTERVAL CLEARING - Press key "6"

This function is used to indicate the state of the interval clearing setting. Press the number "6" key and "INTERVAL CLEARING" will show on display. Press the * Key and display will show Interval Clear: Off (On). Press * - turn On (Off). When turned "ON", the interval (resettable) data will automatically be cleared upon successful completion of a DEX audit. When turned "OFF" it allows for remote auditing devices that clear resettable data manually to be used to clear the data. Press the * Key to toggle or press the "CLR" key to return to "INTERVAL CLEARING". Press "CLR" to return to "SETUP MODE 2".

SET LIGHTS OFF - Press key "7"

The function is used to turn on the "SET LIGHTS OFF TIME" set in "SETUP MODE 1". Press the number "7" key and "SET LIGHTS OFF" will show on display. Press the "*" Key and display will show "Lights Off: Off (On)". Press "*" - turn On (Off). Press the * Key to toggle or press "CLR" to return to "SET LIGHTS OFF". Press "CLR" to return to "SETUP MODE 2".

DOUBLE TALK - Press key "8"

The function is used to turn on or turn off the "Double Talk" feature. Press the number "8" key and "Double Talk" will show on display. Press the "*" Key and display will show current state "On" or "Off". Press "*" to toggle from On to Off. With the display showing the state you wish the mode to be in, press the "CLR" key to return to "Double Talk". Press "CLR" to return to "SETUP MODE 2".

SET STORAGE TIME - Press key "9"

This function is used set the Time, Date, and Day when Storage Temperature will be ON. Press the number "9" and "SET STORAGE TIME" will show across display. Set Storage Time can be set in the same manner as "SET NOT AVAIL TIME" covered in the Initial Programming Section of this manual.

SET STORAGE TEMP - Press key "0"

This function is used to set Storage Temperature. Press the number "0" key and "SET STORAGE TEMP" will show on display. Set Storage Temp can be set in the same manner as "SET TEMPERATURE" covered in "SERVICE MODE" section of this manual.

SETUP MODE 3

Enter SETUP MODE 3 by opening the main door and pushing the Service button five times. The display will read "SETUP MODE 3".

IMPORTANT: This mode is only used when using an EXE (Executive) Coin Mech.

NEXT ITEM - Press key "A"

EXE or MDB - Press key "B"

Configures the Vender Controller for MDB or EXE (Executive) peripheral communication. Toggles Controller Setting from "EXE Active? Off" to "EXE Active? On". When Off, then the controller will communicate with MDB peripherals. When On, then the controller will communicate with EXE (Executive) peripherals.

Press the letter "B" on the keypad. The display will show "EXE or MDB". Press the "*" Key, the current state of "EXE Active? Off" or "EXE Active? On" will show on display. Press the "*" Key, to toggle from "EXE Active? Off" to "EXE Active? On". With the setting you wish to use showing on display press the CLR Key to return to "EXE or MDB". Press the "CLR" key to return to "SETUP MODE 3" or press the "A" key to advance to the next menu item below.

SET PRICING MODE - Press key "C"

This menu is used to set the price mode to either the Vending Machine Controller holds the prices or the EXE Coin Mech holds the prices.

Toggle Controller Setting from "Price Holding: Off" to "Price Holding: On". When Off, the Vending Machine Controller holds the selection prices. When On, then the EXE (Executive) Coin Mech holds the selection prices.

Press the letter "C" on the keypad. The display will show "SET PRICING MODE". Press the "*" Key, the current state of "Price Holding: Off" or "Price Holding: On" will show on display. Press the "*" Key, to toggle from "Price Holding: Off" to "Price Holding: On". With the setting you wish to use

showing on display press the CLR Key to return to "SET PRICING MODE". Press the "CLR" key to return to "SETUP MODE 3" or press the "A" key to advance to the next menu item below.

ASSIGN PRICELINE - Press key "D"

This menu is used to assign a price line to each selection.

Press the letter "D" on the keypad. The display will show "ASSIGN PRICELINE". Press the "*" Key, display will show "PRICELINE: 01". To set Priceline: 01 prices:

1. **All selections.** Press the keypad numbers of the price you wish to use. As numbers are entered the numbers will shift in from the right as they are entered. Note: The CLR key will remove the last # of the price. Once the desired price is showing on the display press the "*" key and the display will show "All Set", press "*" to enter more prices or CLR to exit to "ASSIGN PRICELINE".
2. **One tray.** Press the keypad numbers of the price you wish to use. As numbers are entered the numbers will shift in from the right as they are entered. Note: The CLR key will remove the last # of the price. Once the desired price is showing on the display press the tray letter desired for setting price. Press "*" and display will show "X (tray letter) Row Set" where X represents the letter of the tray that has been set, press "*" to set more prices or CLR to exit to "ASSIGN PRICELINE".
3. **Single selection.** Press the keypad numbers of the price you wish to use. As numbers are entered the numbers will shift in from the right as they are entered. Note: The CLR key will remove the last # of the price. Once the desired price is showing on the display press the selection followed by * (XY*) desired for setting price, and display will show "XY Selection Set" where XY represents the selection that has been set, press "*" to set more prices or CLR to exit to "ASSIGN PRICELINE".

Press the "CLR" key to return to "SETUP MODE 3" or press the "A" key to advance to the next menu item below.

VIEW PL ASSIGNMENTS - Press key "E"

This menu allows the user to see which selections are assigned to which price lines. Even if price holding id turned off, this menu will show what the price line assignments will be when price holding mode is enabled.

Press the letter "E" on the keypad. The display will show "VIEW PL ASSIGNMENTS". Press the "*" Key to view on display and scroll through the price line assignments. Press the CLR to exit to "VIEW PL ASSIGNMENTS".

Press the "CLR" key to return to "SETUP MODE 3" or press the "A" key to advance to the next menu item below.

VIEW PL VALUE - Press key "F"

This menu allows the user to see each price line held by the EXE Coin Mech. In order to see this value, the "Display Price" feature on the EXE Coin Mech must be turned on. If no price is programmed in the Coin Mech for a requested price line, or if the "Display Price" feature is not turned on in the EXE Coin Mech, then this menu will show "Not Available". Press the letter "F" on the keypad. The display will show "DISPLAY PL VALUE". Press the "*" Key and display will show "Enter Priceline: 0". Enter the desired price line using the numeric keys on the keypad. Press the "*" Key, the display will show "requesting...", after the EXE Coin Mech has responded to the Vending Machine Controller with the value of the price line, it will be shown on display. If the EXE Coin Mech does not respond with the value, then "Not Available" will be displayed. Press the "*" Key to return to "Enter Priceline: 0" or CLR to exit to "VIEW PL VALUE". Press the "CLR" key to return to "SETUP MODE 3" or press the "A" key to advance to the next menu item below.

QUICK PAYBACK - Press key "1"

This menu allows the user to set the Vending Machine Controller to pay back change immediately a vend is requested. With this option set to "Quick Payback: On", the price of the vend is always deducted from the available credit, even if the vender fails to deliver the selected item to the customer. If set to "Quick Payback: Off", the price of the vend is deducted from the available credit after completion of the vend.

Press the number "1" on the keypad. The display will show "QUICK PAYBACK". Press the "*" Key, the current state of "Quick Pay Back: Off" or "Quick Pay Back: On" will show on display. Press the "*" Key, to toggle from "Quick Pay Back: Off" or "Quick Pay Back: On". With the setting you wish to use showing on display press the CLR Key to return to "QUICK PAYBACK". Press the "CLR" key to return to "SETUP MODE 3" or press the "A" key to advance to the next menu item.

SATELLITE (137/937) MODE

Enter SATELLITE MODE by opening the main door and pushing the Service button six times. The display will read "SATELLITE MODE".

Satellite Service Modes

To access these modes press the Service Switch on the BevMax 6 times then press the corresponding letter or number.

- C - Set SAT Price
- D - SAT En Combo Discnts
- E - Number Cmbo Discnts
- 1 - Golden-Eye Policy
- 2 - Set Golden-Eye SEL
- 3 - Check Motor Scan
- 4 - Set Credit Return TO (time out)

NEXT ITEM - Press key "A"

NOT USED - Press key "B"

Set SAT PRICE — Press key "C"

This function is used to assign the regular and secondary prices for all selections in the Satellite (137/937) machine. Secondary prices are only active when the vender is in the Happy Hour mode (Mode 3-2). To access this mode, press the Service Switch 5 times, then press **C** on the selection keypad the display will show "Set Sat Price". Press the "*" key the display will show "1 = Regular Pricing" in the top line and "2 = Secondary Pricing" in the second line. Use the selection keypad to enter which set of prices you want to change.

Note: The following steps are the same for both "Regular Pricing" and "Secondary Pricing." The following steps assume you are setting the "Regular Pricing." Then follow one of the procedures below to set prices.

All Selections

Upon pressing the **1** key the display will show "Regular \$XX.XX". Enter the desired price using the selection keypad the display will change to "PR \$XX.XX" with XX.XX being the price you just entered. Press the "*" key a > will appear under PR \$ on the display. Press the "*" key the display will ask "ALL Prices Set Ok?" Press the "*" key to accept or press the **CLR** key to go back one step without saving the price.

By Shelf

Upon pressing the **1** key the display will show "Regular \$ XX.XX". Enter the desired price using the selection keypad the display will change to "PR \$XX.XX" with XX.XX being the price you just entered. Press the "*" key a > will appear under PR \$ on the display. Enter the first 2 digits of any selection on the shelf that you are changing

(example enter 21 if you want to price the entire top shelf). Press the "*" key the display will ask "SET SHELF X OK?" Press the "*" key to accept or press the **CLR** key to go back one step without saving the price.

By Selection

Upon pressing the **1** key the display will show "Regular \$ XX.XX". Enter the desired price using the selection keypad the display will change to "PR \$XX.XX" with XX.XX being the price you just entered. Press the "*" key a > will appear under PR \$ on the display. Enter the selection number on the keypad. Press the "*" key the display will ask "Price XXX ok? Press the "*" key to accept and continue entering selections at that price or press the **CLR** key to go back one step without saving.

SAT EN COMBO DISCNT

Enable Combo Discount

This function is used to enable/disable the Combo Discount. To access this mode, press the Service Switch 5 times, then press **D** on the selection keypad, the display will show "Sat En Combo Discount". Press the "*" key the display will show the current Combo Discount setting. Press the "*" key to turn the Combo Discount on or off. Press the **CLR** key to return to the menu heading.

NOTE: Once this mode is enabled the stand by message will change to an attract mode showing the following flashing message.

**BUY ANY DRINK
SAVE ON A SNACK!**

IMPORTANT: The Multivend option (Mode 4-1) on the BevMax 4 5800-4 must be enabled for the Combo Discount to function.

NUMBER CMBO DISCNTS

This function is used to view the accountability information for the combo vend. To access this mode, press the Service Switch 5 times, then press **E** on the selection keypad the display will show "Number Combo Discount". Press the "*" key the display will show Total Number XX, where XX is the total number of Combo Discount vends. Press the "*" key, the display will change to Total \$.XX where .XX is the dollar amount discounted. Press the "*" key to return to the Total Number screen or press the **CLR** key to go back one step.

GOLDEN-EYE POLICY

This function is used to set the Golden-Eye Policy. To access this mode, press the Service Switch 5 times, then press **1** on the selection keypad the display will show "Golden-Eye Policy". Press the

“*” key the display will show the current Golden Eye setting on the top line and “*” = XXX, where XXX is the alternate setting either Drop or Home. Press the “*” key to change to the alternate setting.

Notes:

- This mode only sets the operating condition of Golden-Eye.
- Selections are enabled/disabled in Mode 5-2.

SET GOLDEN-EYE SEL

This function is used to set up the Golden-Eye Selections. To access this mode, press the Service Switch 5 times, then press 2 on the selection keypad the display will show “Set Golden-Eye Sel”. Press the “*” key the display will show the selections currently active for Golden Eye in the top line, if necessary press the “*” key to see any subsequent screens. If no selections are currently enabled, the display will show “None Assigned”. The factory default for Golden Eye is all selections enabled. Press the “*” key the display will show “Enter Start Location” use the selection keypad to enter the selection number. Press the “*” key and the display will show “Enter End Location”, use the selection keypad to enter the ending location. See notes below for further explanation.

Notes:

- **To Set Single Selections:** Enter the same starting and ending locations.
- **To Set Entire Shelves:** In the **Start Location** enter 2X * where X represents the shelf number. The display will change to the ending location screen with the last selection of that shelf already displayed. Press “*” to set.
- **To Set Entire Machine:** In the **Start Location** enter 2 * the display will change to show the selection range of the machine in the top line and “Continue? * =Y” in the bottom line. Press “*” to set.
- **To Set a Range of Selections:** Enter the starting selection number into the **Start Location** then enter the last selection number into the **End Location**. Press “*” to set. **Rules: Single Selection, Range, Shelf or Entire Machine**
- When enabling or disabling single selections the opposite state of the current setting will be used. For example: if you currently have selection 210 enabled and you go into change it, it will change to disabled.
- When enabling or disabling a range, shelf or the entire machine. The setting will change to the opposite of the lowest selection number in the range, shelf or machine being set. For example if you are changing the top shelf, and selection 210 is set to enable while 212 -216 are set to disable, then you would be disabling the top shelf from Golden-Eye because the lowest selection number on the shelf was set to enable.

CHECK MOTOR SCAN

This function is used to verify the state of the selection motors in the Satellite (137 or 937 Satellite). To access this Mode, press the Service Switch 5 times, then press 3 on the selection keypad the display will show the results of the last Motor Scan Test. Press the “*” key to scroll through the results. To initiate a new scan of the motors Press the 1 key. The display will say Scanning Motors when completed the display will say Scanning motors done press “*” to continue. Press the “*” key to scroll through the results.

Set Credit Ret TO

This function is used to set the amount of time the customer has to make another selection before their change is returned. During this time period, the customer can make a selection, add more money to make another selection or press the coin return to receive their change. To access this mode, press the Service Switch 5 times, then press 4 on the selection keypad the display will show “Set Credit Ret TO”. Press the “*” key the display will show “Set Credit Return” in the top line and “Timeout : XX:XX in the bottom line, where XX:XX is the currently set timeout. Use the numeric keypad to enter the minutes and seconds. Press the “*” key to lock in the change.

NOTE: The default time is 30 seconds.
Minimum time is 00:00
Maximum time is 05:00

Major Component Description

AC DISTRIBUTION BOX

BevMax 4 5800-4/3800-4
110 VAC units

Main Power Switch / Plug	Interrupts hot side of incoming power to all components in machine.
15 Amp Outlet (110 VAC)	Provides power to Refrigeration unit.
Transformer (T1)	Provides 24 Volt power to the Controller Board.

DN5800-E4/3800-E4
220 VAC units

Main Power Switch / Plug	Interrupts hot side of incoming power to all components in machine.
Receptacle, Panel Mount IEC 320 (220 VAC)	Provides power to Refrigeration unit.

Transformer (T1)

Provides 24 Volt power to the Controller Board.

Service Door Switches

If 2 Switches - Left Switch (10 Amp) – in XY Motor Circuits, Port Door Motor Circuit, and Picker Motor Circuit (Power Interrupt Switch).

If 2 Switches - Right Switch (.1 Amp) – in Controller and Electronic Lock Circuit (Lock Switch).

If One Switch - the red & black wires are in Controller Circuit and the two gray wires are go to XY Motor Circuits, Port Door Motor Circuit, and Picker Motor Circuit. (Power Interrupt Switch).

General Maintenance

The most important facets of proper care and maintenance of your machine are the electrical power supplied to it, leveling, and cleanliness of the machine.

POWER

Domestically the machine must be connected to a dedicated 120 VAC, 15 Amp circuit (U.S. and Canada). Refer to the cabinet serial number plate to determine the correct voltage and frequency for the machine.

CAUTION:
REMOVE POWER TO THE AC DISTRIBUTION BOX BEFORE CLEANING OR WHEN ANY ELECTRICAL COMPONENTS ARE CONNECTED / DISCONNECTED FOR TESTING OR REPLACEMENT.

Periodically inspect the power supply cord for damage. If the cord or plug is worn or damaged, it must be replaced with a power supply cord of the same type, size and specification as originally provided with the machine. DO NOT USE THE VENDING MACHINE UNTIL THE WORN OR DAMAGED CORD IS REPLACED.

The Ground Fault Circuit Interrupter (GFCI) must be tested frequently and before each use in accordance with the instructions provided on the GFCI device. **IF THE GFCI DOES NOT PASS THE TEST, DO NOT USE THE MACHINE.** Unplug the supply cord from the receptacle and call the Crane Merchandising Systems Technical Support Group for assistance at 1-803-266-5001.

CAUTION:
REMOVE POWER TO THE AC DISTRIBUTION BOX BEFORE CLEANING OR WHEN ANY ELECTRICAL COMPONENTS ARE CONNECTED / DISCONNECTED FOR TESTING OR REPLACEMENT.

CLEANING

DO NOT USE A WATER JET OR NOZZLE TO CLEAN THE VENDER

GLASS DOOR

The display glass should be cleaned inside and out with paper towels and glass or non-abrasive all-purpose cleaner. The gasket around the product door should be wiped down using warm water, any mild general purpose, non-abrasive cleaner and a soft towel. Never lubricate the gasket and always check for cracking or deformities which may cause leaks. Replace if necessary.

VERTICAL LAMP LENS COVER

Then vertical lamp lens covers are of a polycarbonate material. Clean as needed with warm water only. Ammonia or alcohol based products will damage the lens cover.

TRAYS / TRAY INSERTS

The trays and tray inserts should be cleaned periodically using warm water and a mild general purpose, non-abrasive cleaner. Care should be taken to ensure debris does not enter the gear box assemblies. **DO NOT USE SOLVENTS OR ABRASIVE MATERIALS TO CLEAN ANY PORTION OF THE TRAY.**

DOOR LIGHTING

The machine is designed with an energy efficient T8 Lighting System or LED Lighting System. To ensure continued reliable operation, replace only with the same type and size lamps. Lamps must be properly installed and seated in the lamp holders.

SLIDE/PUSHER ASSEMBLY

The slide/pusher assembly should be cleaned periodically using warm water and any mild general-purpose non-abrasive cleaner. After drying, the slide assembly needs to have a coat of Armoral applied. Care should be taken to ensure debris does not enter the gear box assemblies. **DO NOT USE SOLVENTS OR ABRASIVE MATERIALS TO CLEAN ANY PORTION OF THE TRAY.**

CABINET

Wash the cabinet with a good detergent or soap mixed in warm water. Wax the vender often with a good grade of automobile wax. Any corrosion inside the vender should be removed with fine steel wool and the area should be painted with white paint.

Repair any scratches on painted surfaces to prevent corrosion.

NEW CONTROL BOARD INSTALLATION

Set Model Number. On power up the display will show "Reset Model? Continue? * = Yes CLR = No". Pres the * key and display will show "No Model Set Save? A = ^ (scroll up) * = Yes CLR = No". Press key A to scroll through available model numbers DN5800-4, DN3800-4, DN5800-E4 (export), DN3800-E4 (export). With vender model displayed that you are installing board press the * key to save.

DRAIN PAN, DRAIN TUBE, AND DRAIN HOSE



To prevent mold and mildew growth, and to avoid personal injury or property damage, the drain pan, drain tube, and drain hose must be properly aligned and routed. Ensure nothing obstructs the drain tube or drain hose and that the hose is not bent, pinched, or twisted in such a way as to prevent the flow of condensate. Periodically inspect the drain pan, drain tube, and drain hose for alignment and the presence of dirt, debris, mold, and mildew. Clean as needed.

WARNING

THE COMPRESSOR ELECTRICAL CIRCUIT IS ALWAYS LIVE WHEN THE PLUG IS CONNECTED TO AN ELECTRICAL OUTLET.

REFRIGERATION CONDENSER

Clean the condenser periodically of dirt or lint build-up. Remove the build up with a brush or vacuum, or blow the dirt out of the condenser with compressed air and approved safety nozzle. Ensure nothing obstructs air intake at the bottom of the main door. Ensure nothing obstructs air exhaust at the rear of the cabinet.

COIN ACCEPTOR

Follow the Coin Acceptor Manufacturer's instructions.

LUBRICATING THE VENDER

The vender refrigeration system does not require any field lubrication. The hermetic refrigeration system and fan motors are manufactured with lifetime lubrication.

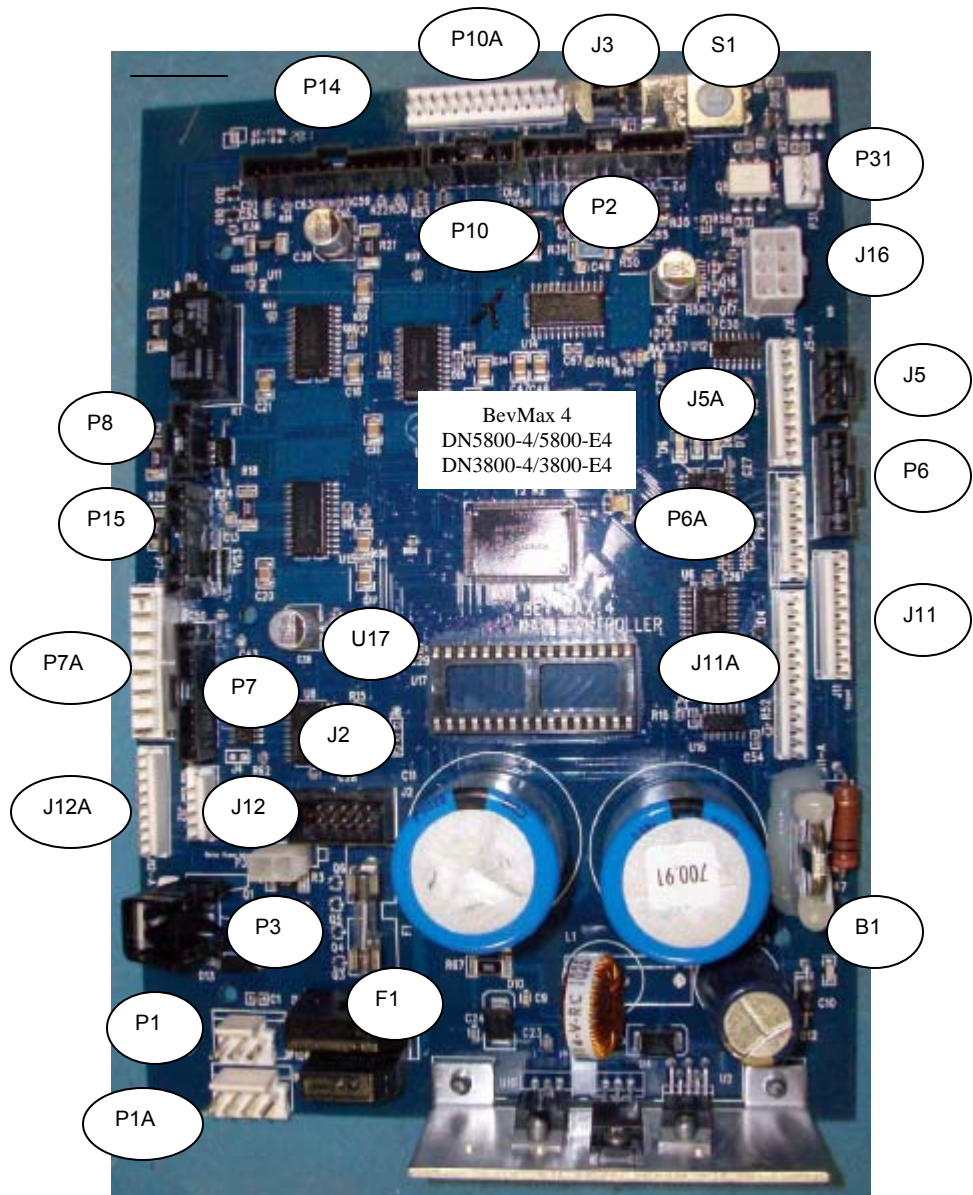

BEVMAX 4 DN5800-4/3800-4/5800-E4/3800-E4 MDB/EXE CONTROLLER CONNECTIONS

CONNECTION NOT USED	CONNECTION PEPSI/GENERIC	DESCRIPTION	CONNECTION NOT USED	CONNECTION PEPSI/GENERIC	DESCRIPTION
P1A	P1	Power from AC Distribution Box		F1	Fuse
	P14	Cup Signal & Y Encoder	J5A	J5	DEX
	P15	X Motor & Encoder	J11A	J11	Keypad
	P2	Product Port	J12A	J12	Temp Sensor
P6A	P6	Display		J16	Multi Drop Bus
P7A	P7	Relays		U17	EPROM Socket
	P8	Y & Cup Motors		P3	Door Switch XY
P10A	P10	Door Switch		B1	Battery
	J2	Supplier Programming Connector		S1	Service Switch
	P31	Executive Interface		J3	Dongle Harness

BEVMAX 4 5800-4/3800-4 TROUBLESHOOTING “XY” ISSUES

1. Selection will not vend.
 - a. Does a different selection vend?
 - i. Perform TEST VEND in TEST MENU ensure proper selection vends.
 - ii. Check Custom Space-To-Sales has been enabled.
 1. Check STS configuration in SETUP MODE 2 Menu.
 - b. Did the gate actuate at all?
 - i. Plunger cycled but gate but did not fully actuate.
 1. Gate Sticking.
 - a. Check plunger to target alignment in position test.
 - b. Shuttle bad.
 - c. Bent pins.
 - d. Check gear box & follower.
 2. Possible delivery cup assembly position alignment problem
 - a. Plunger should hit approximately ¼” from top edge of target.
 - i. Adjust shelf offset see programming “Test Vend/Position Test”.
 - b. Perform vend test on selections.
 - i. Only occurs on one column.
 1. Defective target.
 2. Defective gear box.
 3. Defective follower.
 - ii. Occurs on entire shelf.
 1. Shelf not secured on supports.
 2. Position alignment.
 - iii. Occurs on same column, multiple shelves (A2, B2, C2, D2, E2).
 1. Shelf not secured on supports.
 2. Position alignment.
 3. Plunger did not cycle fully.
 - a. Replace delivery cup assembly.
 - b. Replace control board.
 - ii. Gate did actuate
 1. Product and gate mismatch.
 2. Possible delivery cup assembly position alignment problem
 - a. Plunger should hit approximately ¼” from top edge of target.
 - i. Adjust position alignment see programming “Test Vend/Position Test”.
 - b. Perform vend test on selections.
 - i. Only occurs on one column.
 1. Defective target.
 2. Defective gear box.
 3. Defective follower.
 3. Dirty / worn tray slide with pusher.
 - a. Check slide with pusher.
 2. Delivery Cup Assembly Plunger Issues.
 - a. Plunger jam/dry vend.
 - i. Syrup/dirt causing plunger to stick.
 - ii. Replace delivery cup assembly.
 - iii. Replace control board.
 1. Software did not attempt to vend

- a. Check error list. Does error list show “VEND ERR”, with selection included in vend error list when pressing “A”?
 - b. A previous vend operation or vend test failed.
 - 2. Software has selection identified as “sold out”.
 - 3. Selection is placed under SETUP MODE, HEALTH GUARD.
 - 4. Selection is placed under SERVICE MODE, SET COOL DOWN function.
 - 5. Selection has been disabled through SERVICE MODE, ENABLE ITEM function.
 - b. Plunger Hits Chassis.
 - i. Check tray is level and secured to tray supports.
 - ii. Check harness connections.
 - iii. Check X motor (bottom right).
 - iv. Check current software is being used 804,927,700.91 or higher.
 - c. Plunger Stays Out.
 - i. Check for syrup or dirt build up.
 - ii. Check Harness connections.
 - iii. Check current software is being used 804,927,700.91 or higher.
3. Delivery Cup Assembly Will Not Go Home.
 - a. Is there a “Vend Error” on the display?
 - i. If yes check the “Y” (lower) and “X” (top far left) home switches.
 - 1. In Test Vend/Position Test with the top door switch pulled out:
 - a. At the home position the “Y” (lower) home switch will light a green LED on the control board.
 - b. At the home position the “X” (top far left) home switch will light an amber LED on the control board.
 - i. Adjust the X drive belt at the bottom left belt clamp.
 - b. Check dynamic tensioner.
 - i. On rear belt it should be 6” from the bottom.
 - ii. If one is installed on the front belt it should be 6” from the top.
4. Elevator will not move vertically.
 - a. Perform TEST VEND/POSITION TEST in TEST MENU to test movement.
 - b. Check top door switch.
 - i. Is it functioning?
 - ii. Is it being made when door is closed?
 - c. Check the Delivery Cup Plunger & Plunger Home Switch.
 - i. If plunger arm is stuck out it will shut down XY delivery system.
 - ii. If plunger arm home switch fails it will shut down XY delivery system.
 - d. Check the 10 pin harness connector to the “Y” motor.
 - e. Check rollers.
 - f. Check harness and motor.
 - g. Replace control board.
5. Elevator will not move horizontally.
 - a. Perform TEST VEND/POSITION TEST in TEST MENU to test movement.
 - b. Check top door switch
 - i. Is it functioning?
 - ii. Is it being made when door is shut?
 - c. Check the lower and top far left home switches.
 - i. In Test Vend/Position Test with the top door switch pulled out:
 - 1. At the home position the “Y” (lower) home switch will light a green LED on the control board.

2. At the home position the “X” (top far left) home switch will light an amber LED on the control board.
 - a. Adjust the X drive belt.
 - d. Check the Delivery Cup Plunger & Plunger Home Switch
 - i. If plunger arm is stuck out it will shut down XY delivery system.
 - ii. If plunger arm home switch fails it will shut down XY delivery system.
 - e. Check rollers.
 - f. Check harness and motor.
 - g. Replace control board.
6. Product Will Not Load From Delivery Cup Assembly To Port Assembly.
 - a. Perform TEST VEND/POSITION TEST in TEST MENU to test movement.
 - b. Check current software is being used 804,927,700.91 or higher.
 - c. Check belt tension.
 - d. Check Service Wall Port Door Assembly is securely installed.
7. Port Assembly On Service Door Will Not Open.
 - a. Perform TEST VEND/POSITION TEST in TEST MENU to test movement.
 - i. Port open will light the Amber LED on control board
 - ii. Port closed will light the Green LED on control board
 - b. Check fuse 1 by door switch in service area.
 - c. Check for syrup or dirt build up.
 - d. Replace port assembly.
 - e. Check harness and motor.
 - f. Replace control board.
8. Double Vend From Gate
 - a. Is correct gate assembly used in early models.
 - i. Small diameter cans may only be vended from tray A in early models.
 - ii. Large diameter packages may not be vended from tray A in early models.
 - b. Too many packages loaded in column.
 - c. Is software 804,927,700.91 or higher?
 - d. Is Plunger Return Spring current revision level 801,701,67x.x1?
 - e. Is Cup Motor Cam current revision level 801,202,020.01 or higher?
 - f. Check the trigger on the Plunger Assembly is not bent 805,202,75x.x1.
 - g. Check the Picker Cup Ribbon Cable for bad connection or damage 804,923,74x.x1.
 - h. Check the Y E Chain Harness for bad connection or damage 804,924,79x.x1.
 - i. Check the X/Y E Chain Harness for bad connection damage 804,928,26x.x1.
 - j. Change Y Motor Board 804,925,32x.x1.
 - k. Change Delivery (Picker) Cup Base Board 804,927,65x.x1.
9. Package Not Sliding On Slide Assembly.
 - a. Vender not level.
 - b. Slide not installed correctly.
 - c. Slide dirty. Clean and apply Armoral or Food Grade Silicone.
10. Delivery Cup Assembly Caught On Tray
 - a. Check vender is level.
 - b. Check rollers.

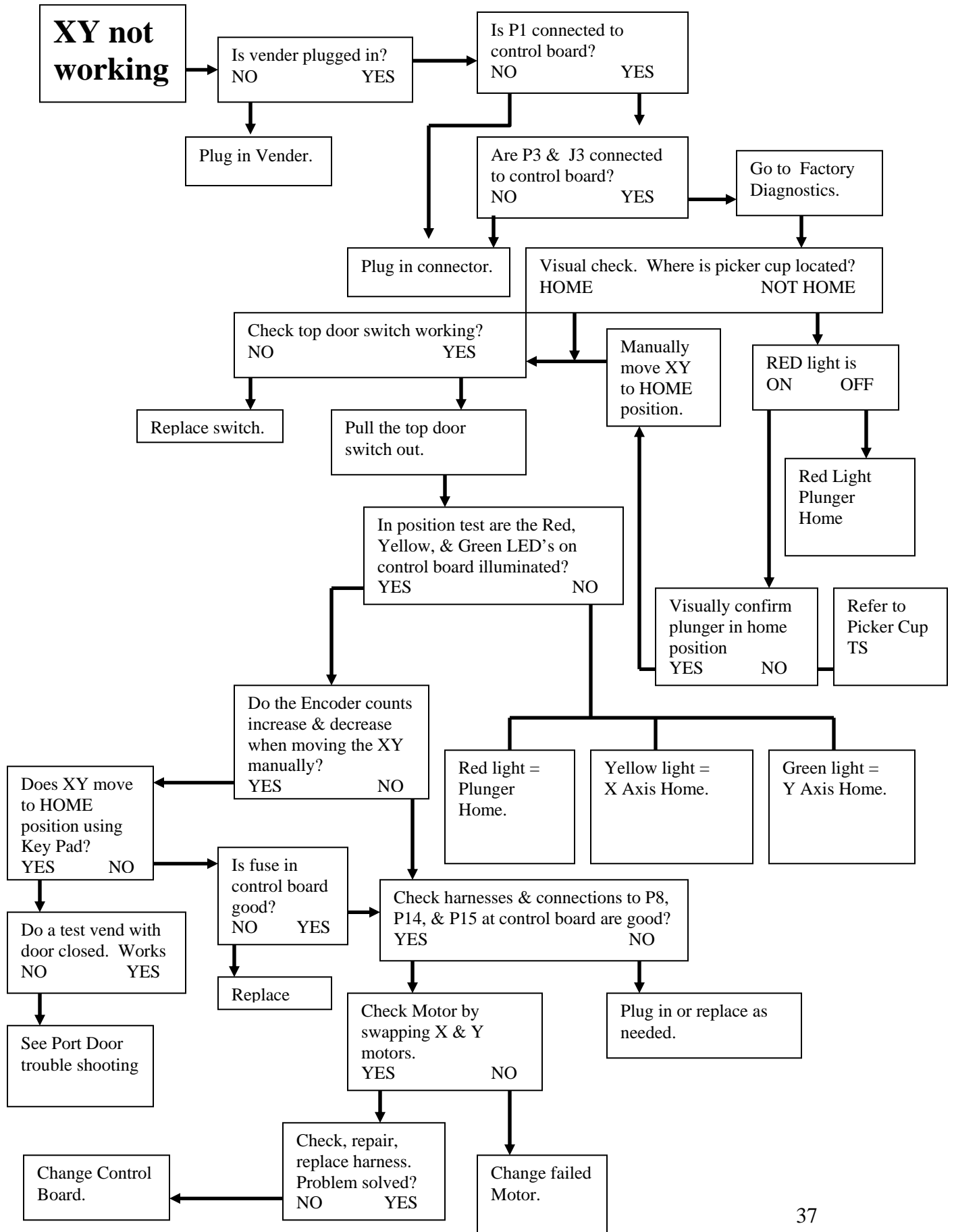

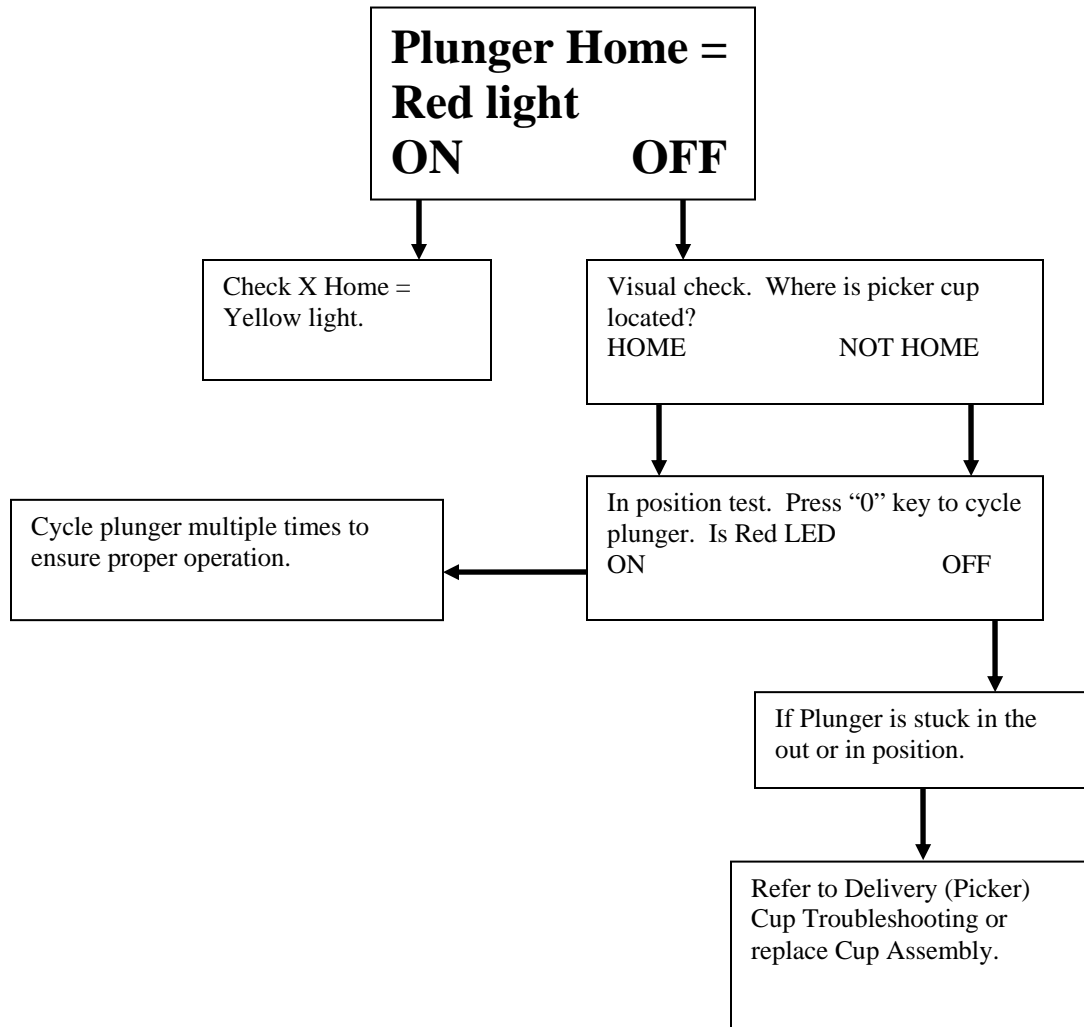

**X Axis Home =
Yellow light
ON OFF**

Check Y Home =
Green Light

Manually activate the switch
and light cycles on and off.
YES NO

Manually move cup to A9 and
pull top door switch out.

Check, repair, or replace switch
or harness. Problem solved?
YES NO

Press the "F" key. Picker Cup
goes to the home position?
YES NO

Do a Vend
Test with
Door Closed.

Is the Yellow
LED on?
YES NO

Does motor run?
YES NO

Replace
control board.

Check belt
and pulley.

Is the display showing Encoder count with
a "1" at the end of the X Axis code?

##### 1	##### 1
X axis	Y axis

 YES NO

Check, repair, replace
harness. Problem solved?
YES NO

"1" showing = a switch or
ground wire issue.

"0" showing = a
mechanical
obstruction.
NO YES

Check & replace motor.
Problem solved?
YES NO

Replace
control board.

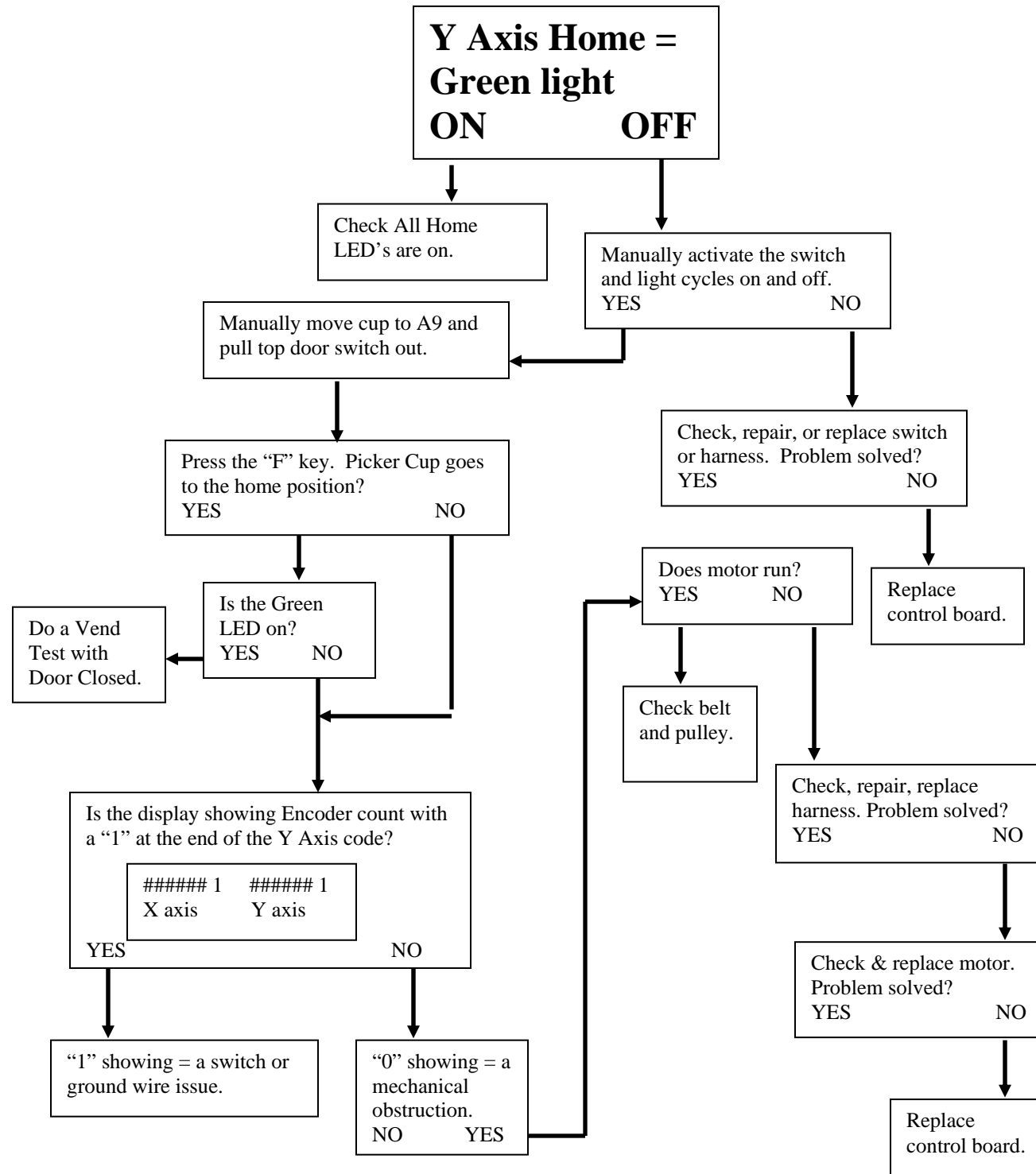

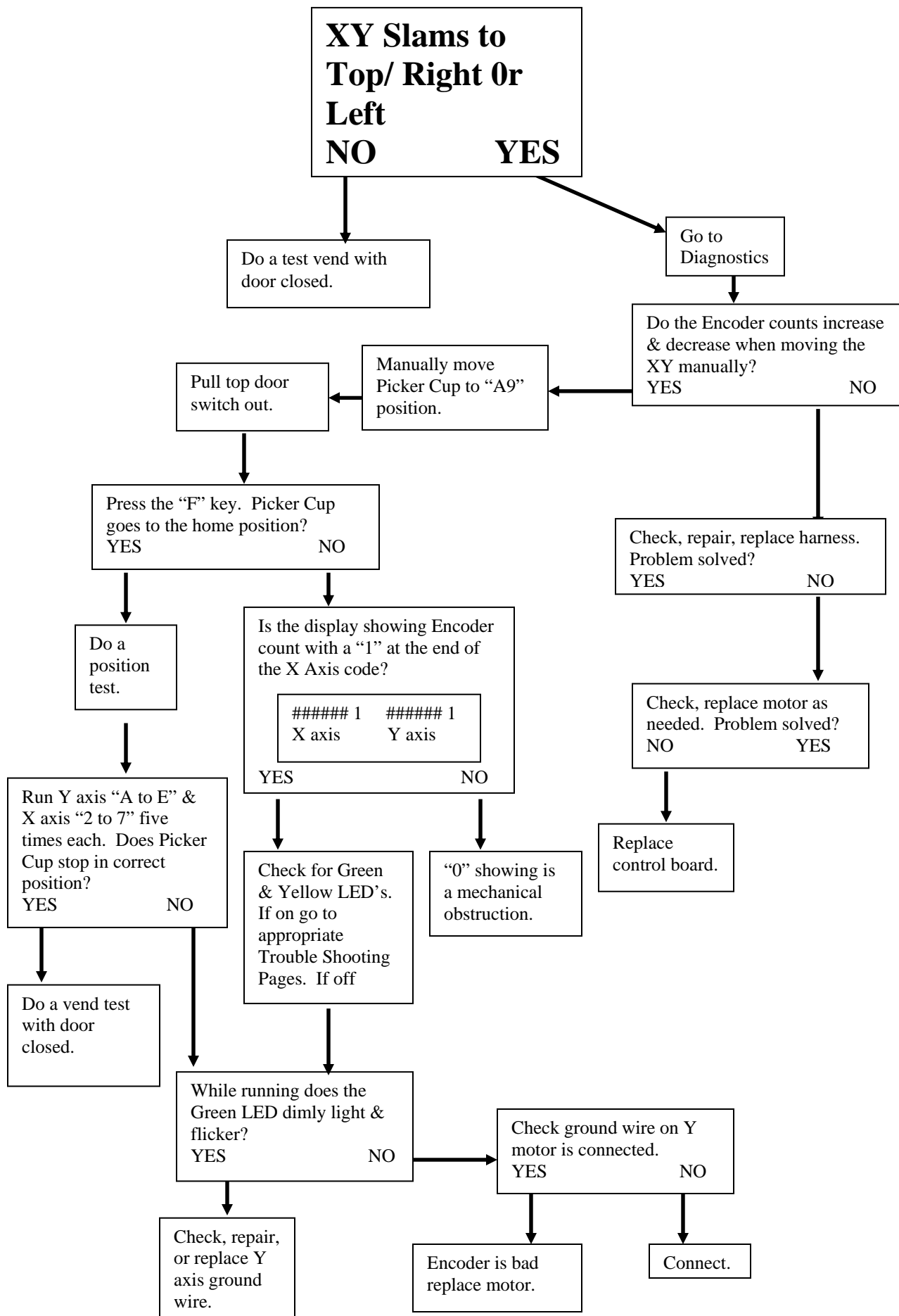

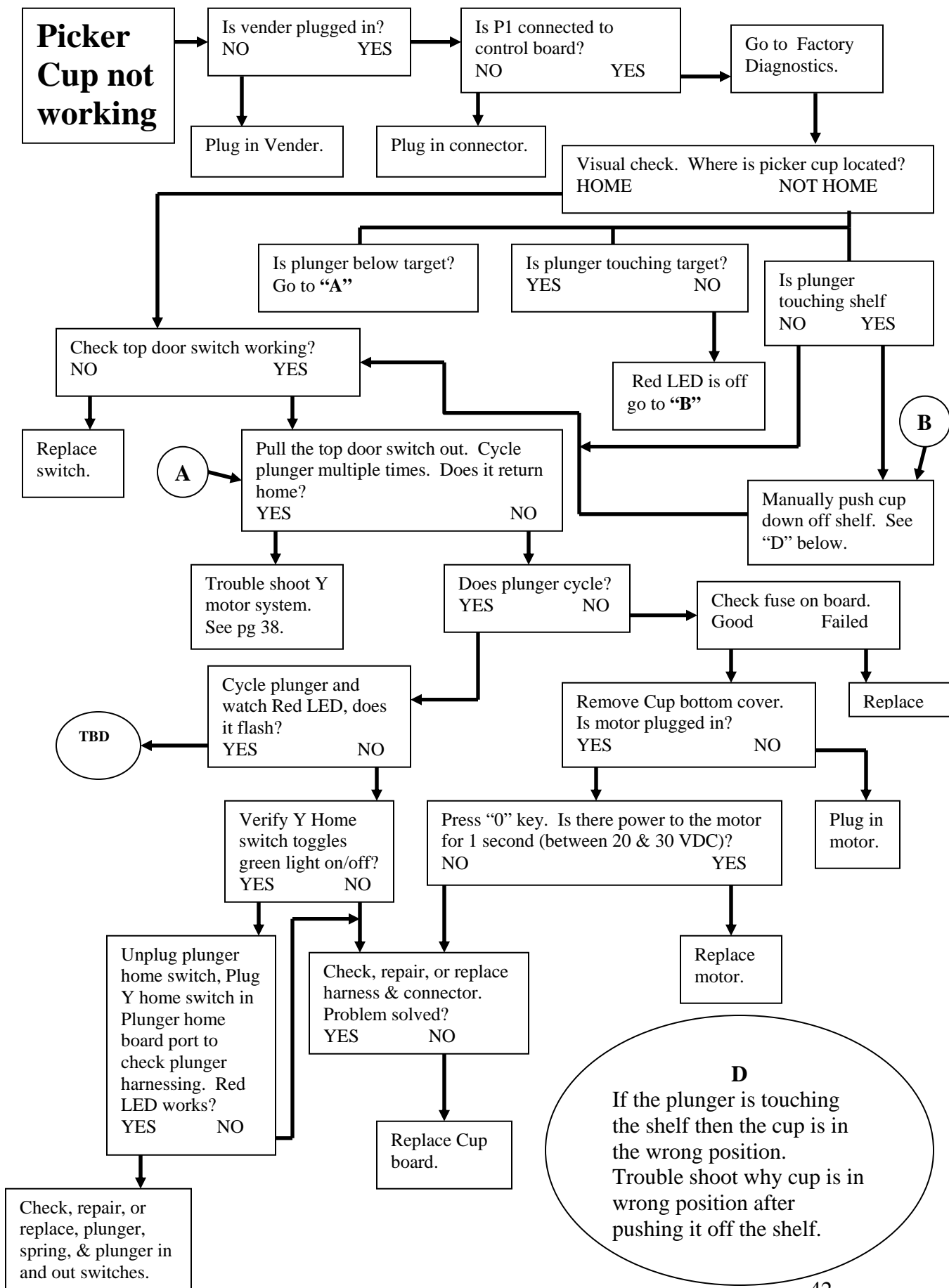

CUP AT WRONG LOCATION HIGH/LOW or Y AXIS

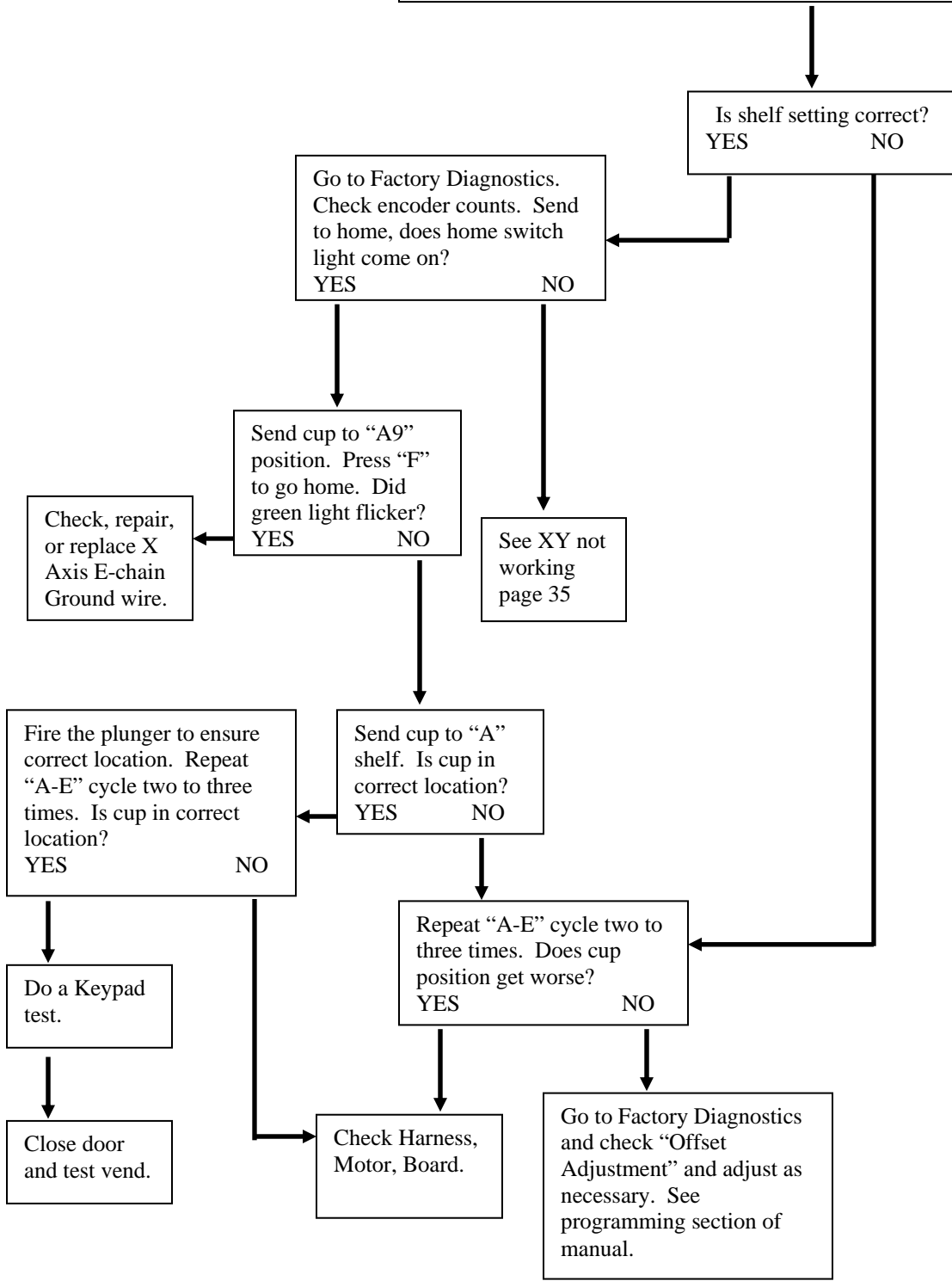

CUP AT WRONG LOCATION LEFT /RIGHT or X AXIS

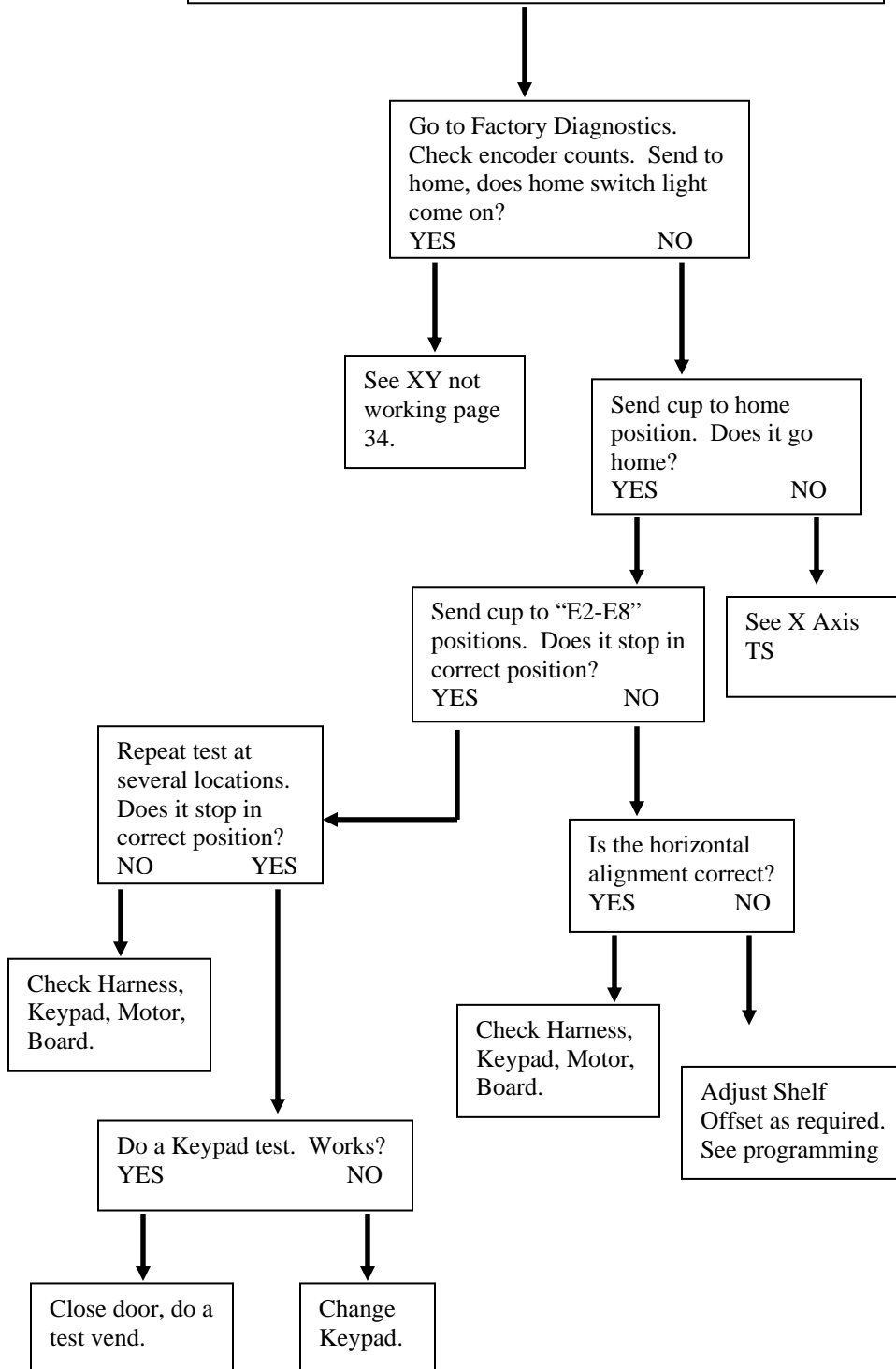

DELIVERY PORT DOOR WORKS IN FACTORY DIAGNOSTICS BUT NOT IN SALES MODE

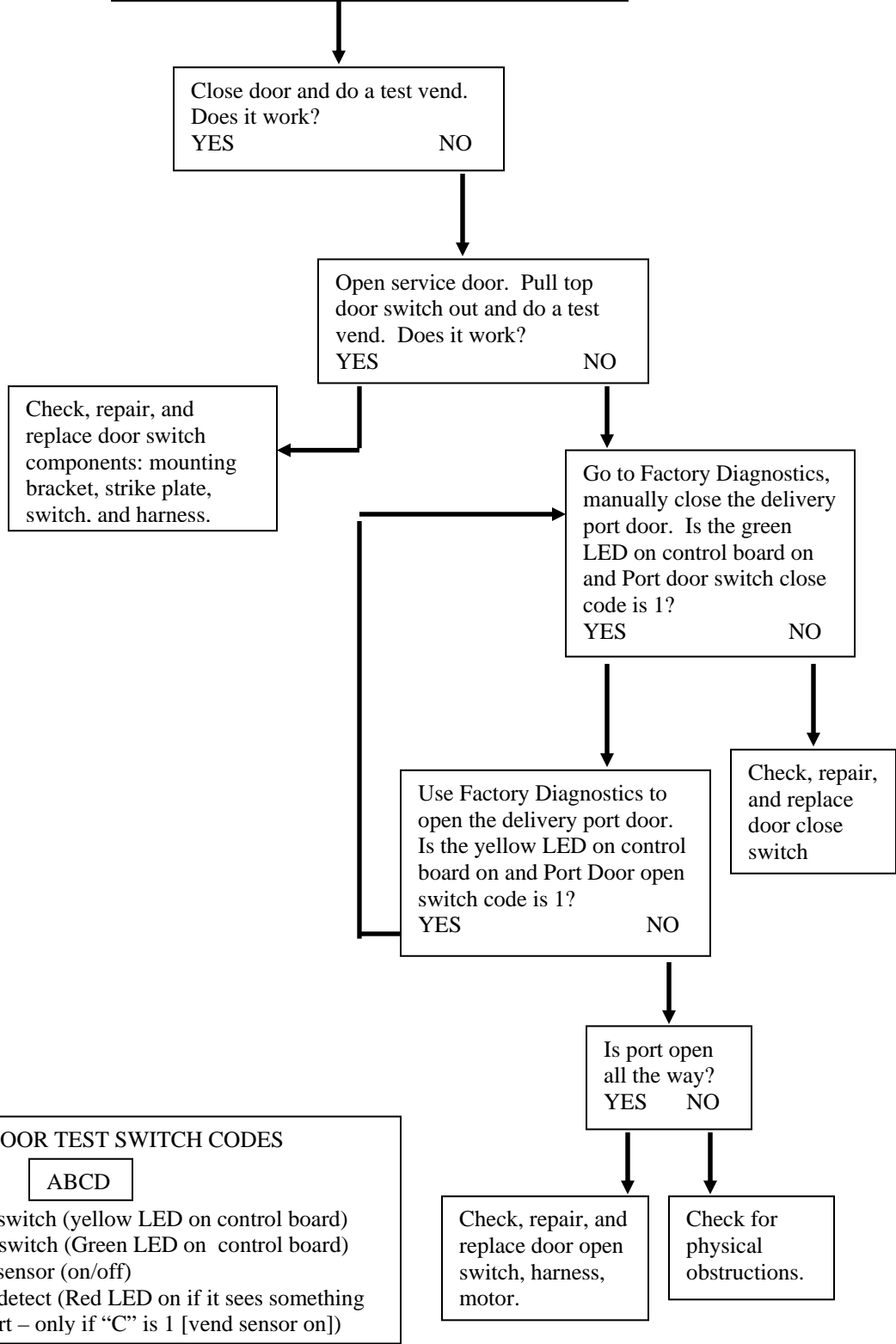

PORT DOOR TEST SWITCH CODES

ABCD

Position A = Open switch (yellow LED on control board)
 Position B = Close switch (Green LED on control board)
 Position C = Vend sensor (on/off)
 Position D = Vend detect (Red LED on if it sees something in port – only if “C” is 1 [vend sensor on])

COIN ACCEPTANCE ISSUES

PROBLEM	CAUSE	FIX
Coins Returned to Customer With No Credit Issued	<ol style="list-style-type: none"> 1. Coin Jam in Mech 2. Flight Deck Dirty 3. No Power to Mech 4. Coin Return Lever Activated 5. Vender in Test Mode 6. Not Available Time Set 7. Defective Coin Mech 	<ol style="list-style-type: none"> 1. Clear Jam and Test 2. Clean Flight Deck 3. Check Harness, Changer to VCU 4. Adjust Coin Return Lever 5. Close Service Door 6. Disable Not Available Time 7. Replace Mech
Will Not Payback Coins	<ol style="list-style-type: none"> 1. No Power to Mech 2. No Coins in Tubes 3. Tubes Programmed Incorrectly (4 Tube Mech) 4. Defective Coin Mech 	<ol style="list-style-type: none"> 1. Check / Replace MDB Harness 2. Fill Coin Tubes with Coins 3. Reprogram per Manufacturer Recommendation 4. Replace Coin Mech

DOLLAR BILL ACCEPTANCE ISSUES

PROBLEM	CAUSE	FIX
Bill Validator will not run.	Prices / tube cash conditions.	Check Mech Tubes.
Takes Bill in Then Rejects it		Check Validator or Replace
Stacks Bill While in Escrow Mode	Max Price Not Yet Reached	
Bill Error Listed in Test Mode	Communication Error with Bill Validator. Bill Validator Reported Error.	
Takes Bill, Gives No Credit	Board, Harness, Validator	Check or Replace Validator Harness, Replace Board

CONTROL BOARD (VMC)

PROBLEM	CAUSE	FIX
No Power to Controller.	1. AC Box	1. Replace AC box.
??????? Showing on Display	<ol style="list-style-type: none"> 1. Incorrect Input to Controller 2. Low or Missing 24 Volts 	
Out of Order or other error codes showing on display	RAM Error	Refer to Programming Section, Test Mode, List Errors for specific error codes and cures.
Temp out of Service	No Vendable Selections	

These charts are intended as a guide to isolate and correct most problems you might encounter. Should your machine show 'OUT OF SERVICE', go in the TEST MODE and press "B" to list errors.

ALL COINS ARE REJECTED

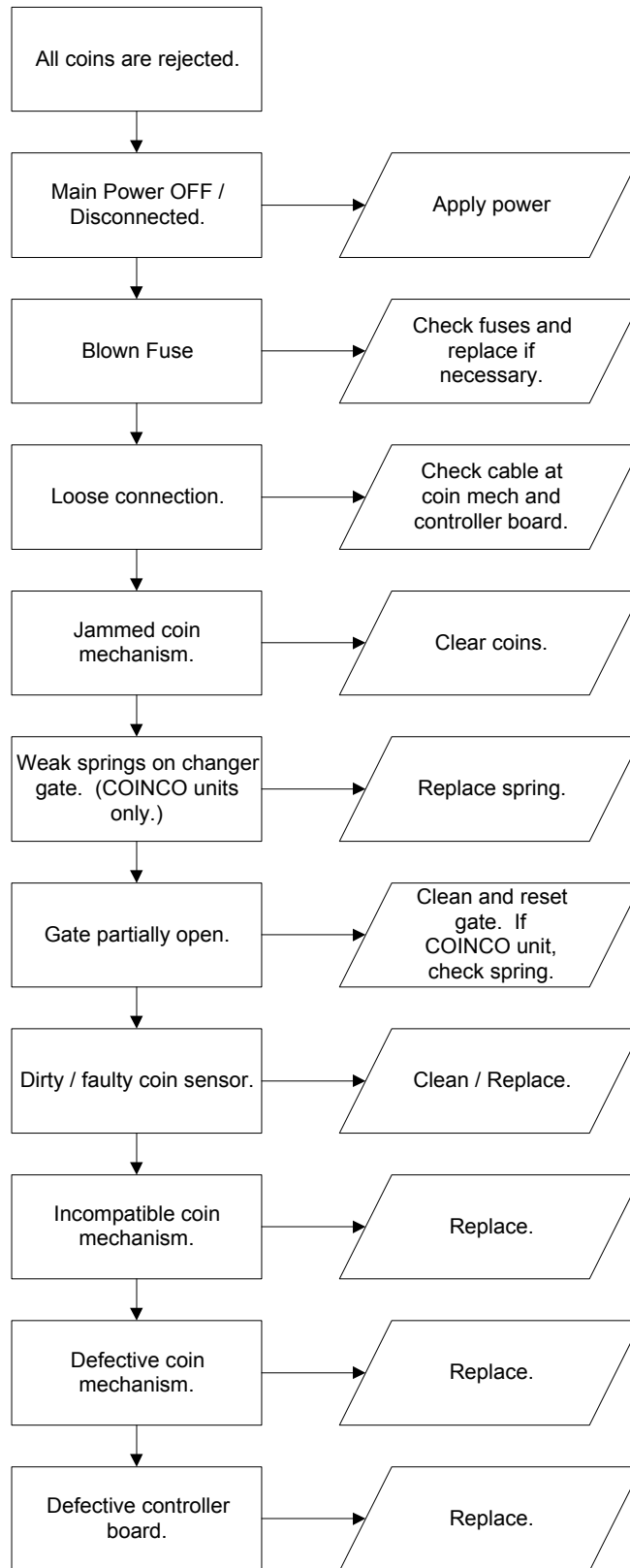

ALL BILLS ARE REJECTED

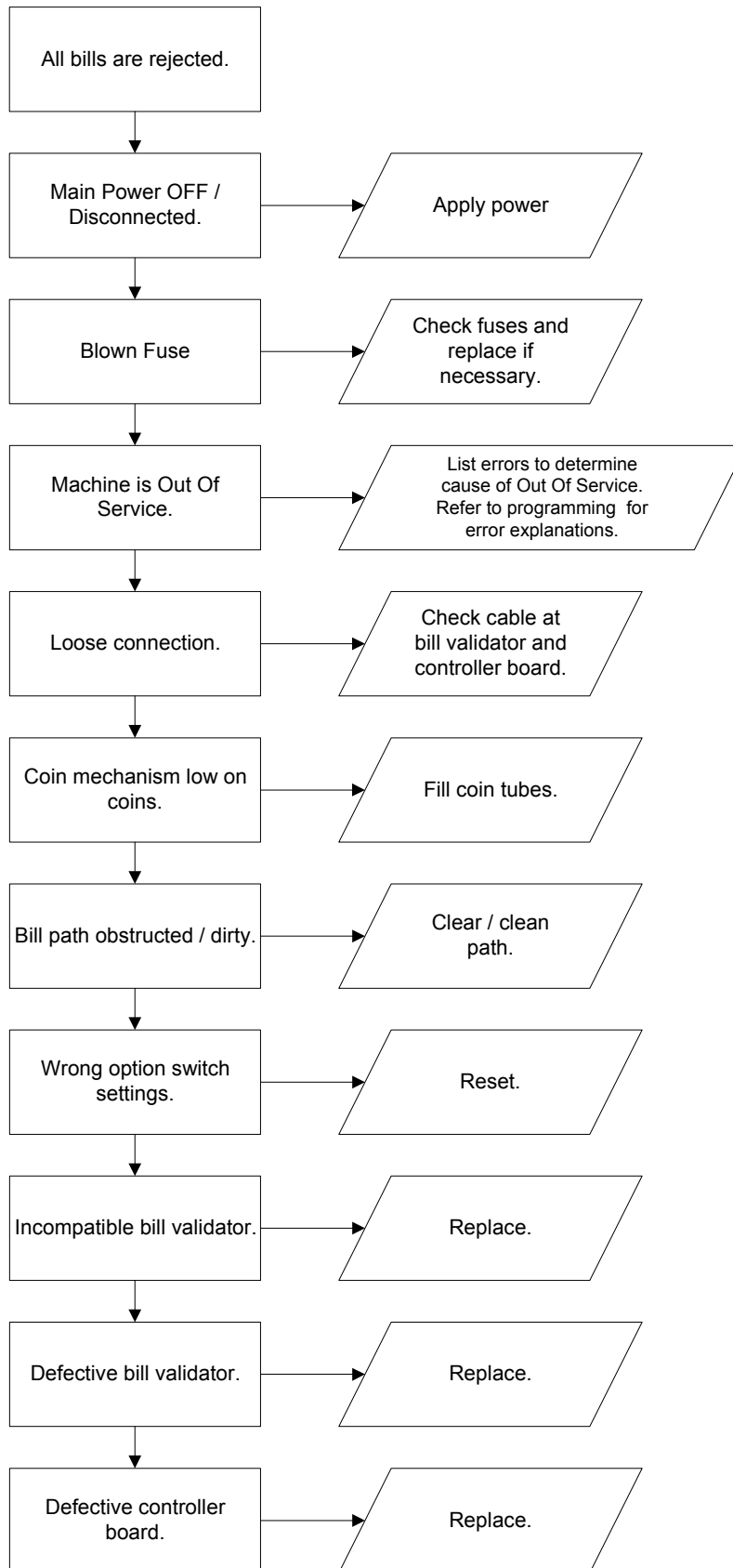

INCORRECT CHANGE DISPENSED

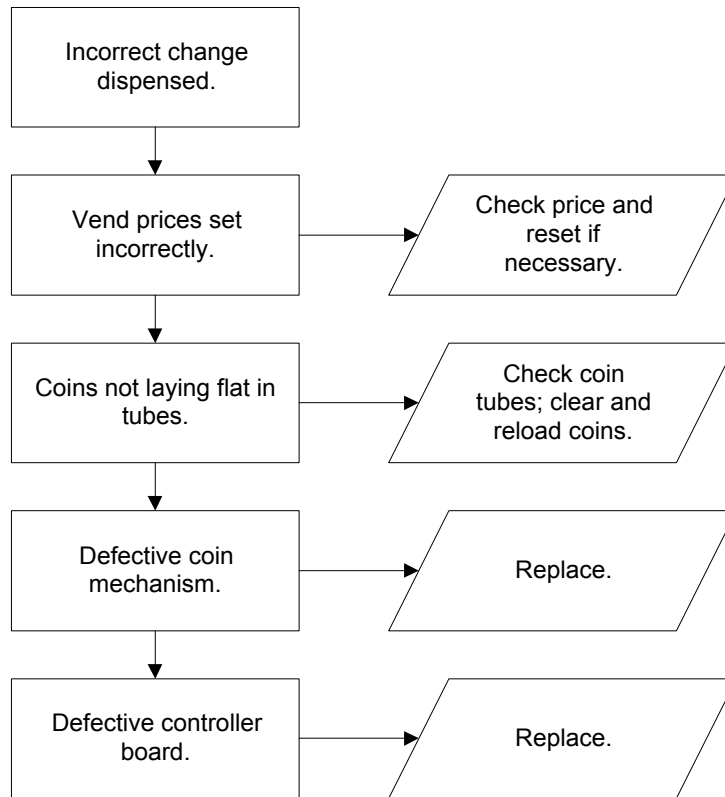

SELECTION WILL NOT VEND



ICE / FROST ON EVAPORATOR

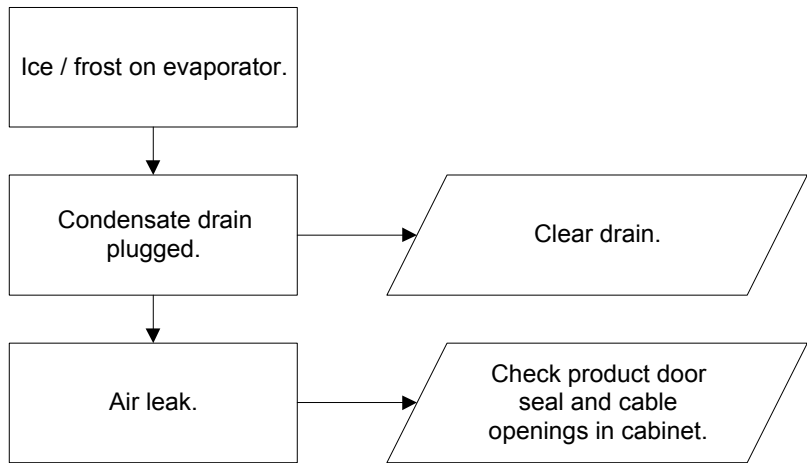

CONDENSATE ON OUTSIDE OF PRODUCT DOOR

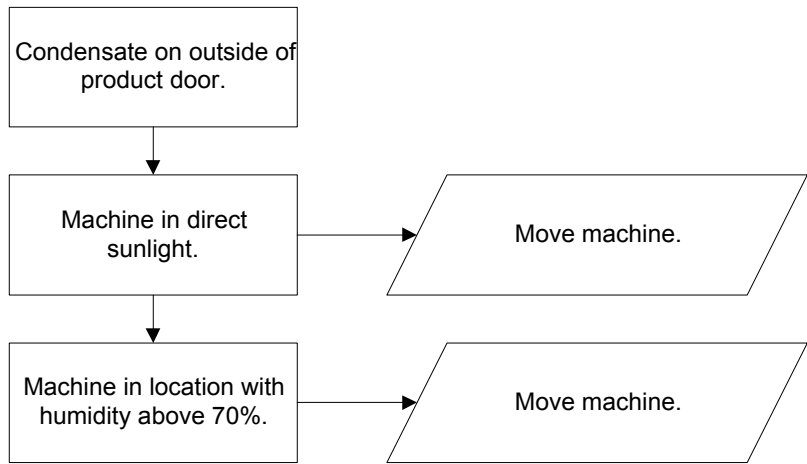

COMPRESSOR WILL NOT STOP

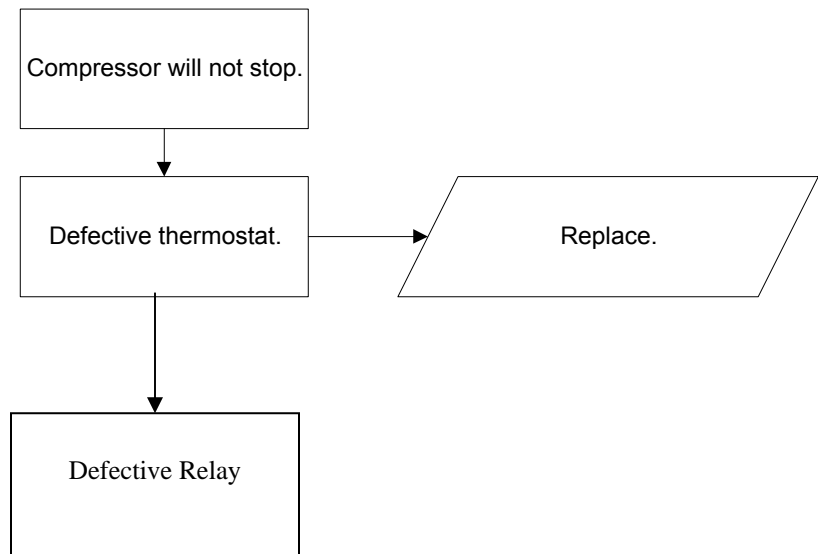

COMPRESSOR WILL NOT START

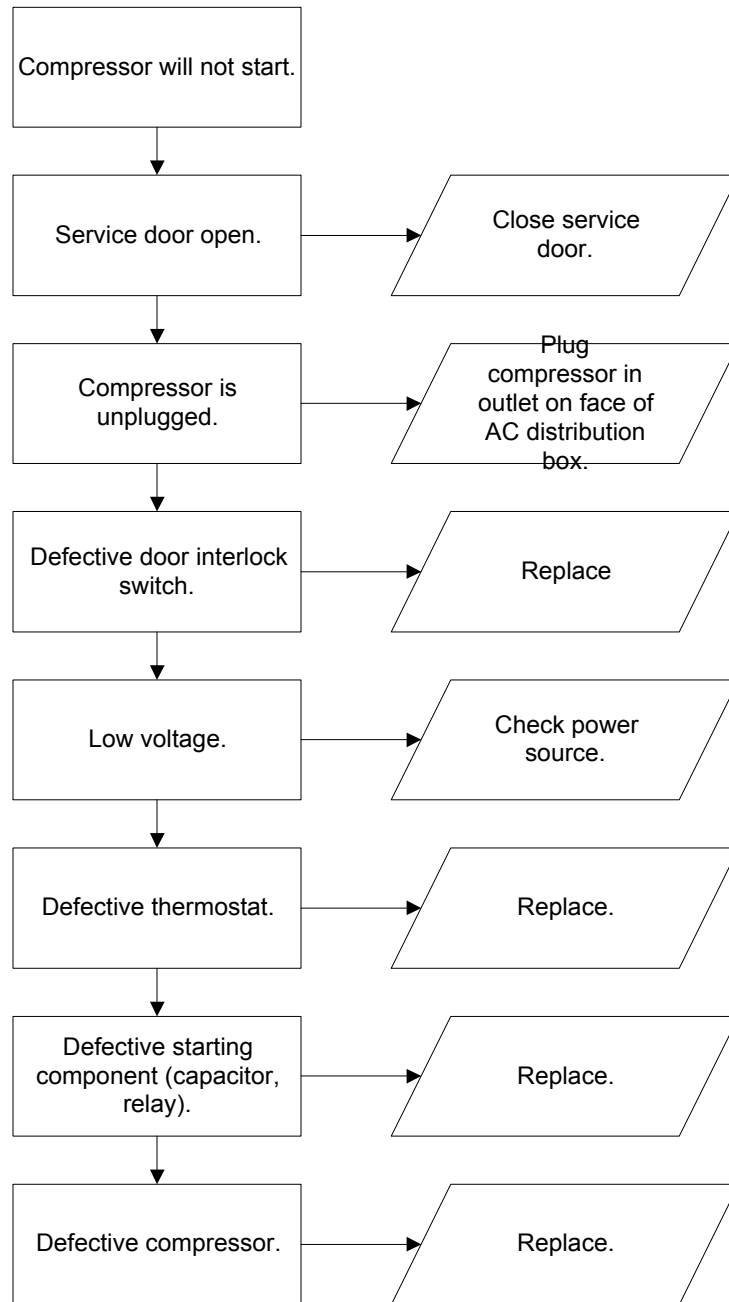

Troubleshooting Tip: Use a short 15 Amp extension cord and plug the compressor directly into the wall outlet. This will bypass the AC distribution box.
Note: For Testing Purposes Only.

MACHINE NOT COOLING

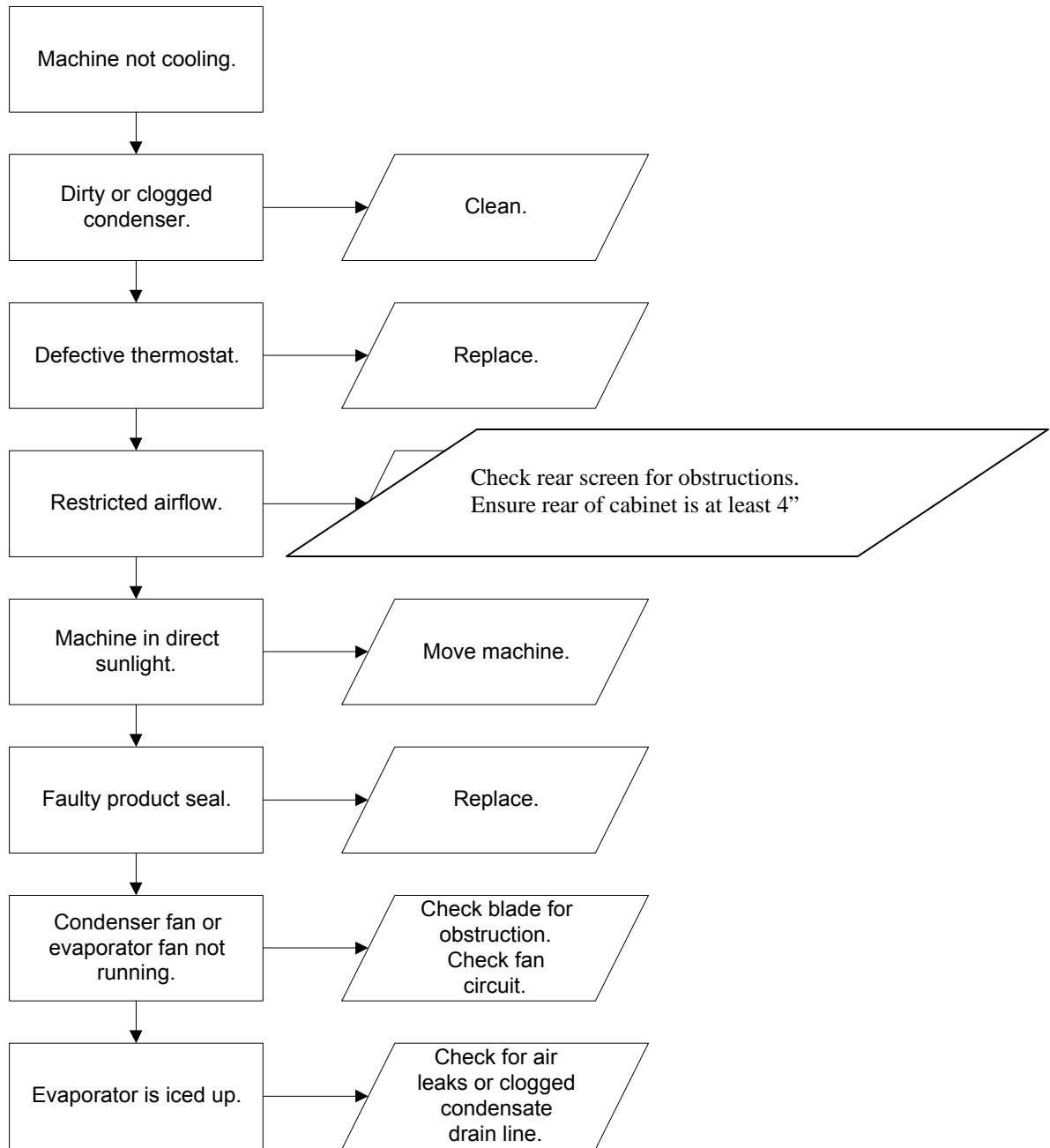

BevMax 4 5800-4/3800-4 Domestic Block Diagram

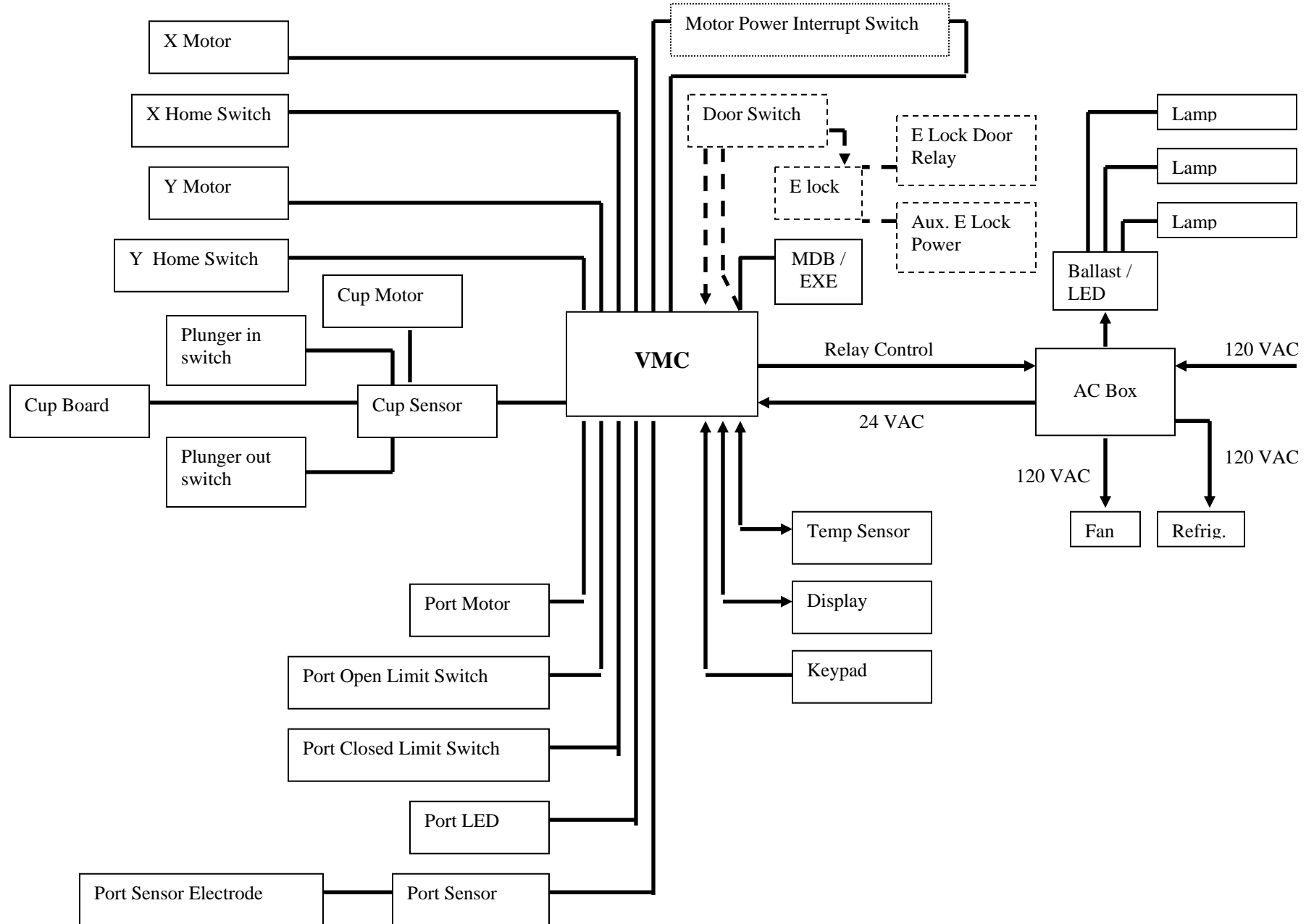

BevMax 4 5800-E4.3800-E4 Export Block Diagram

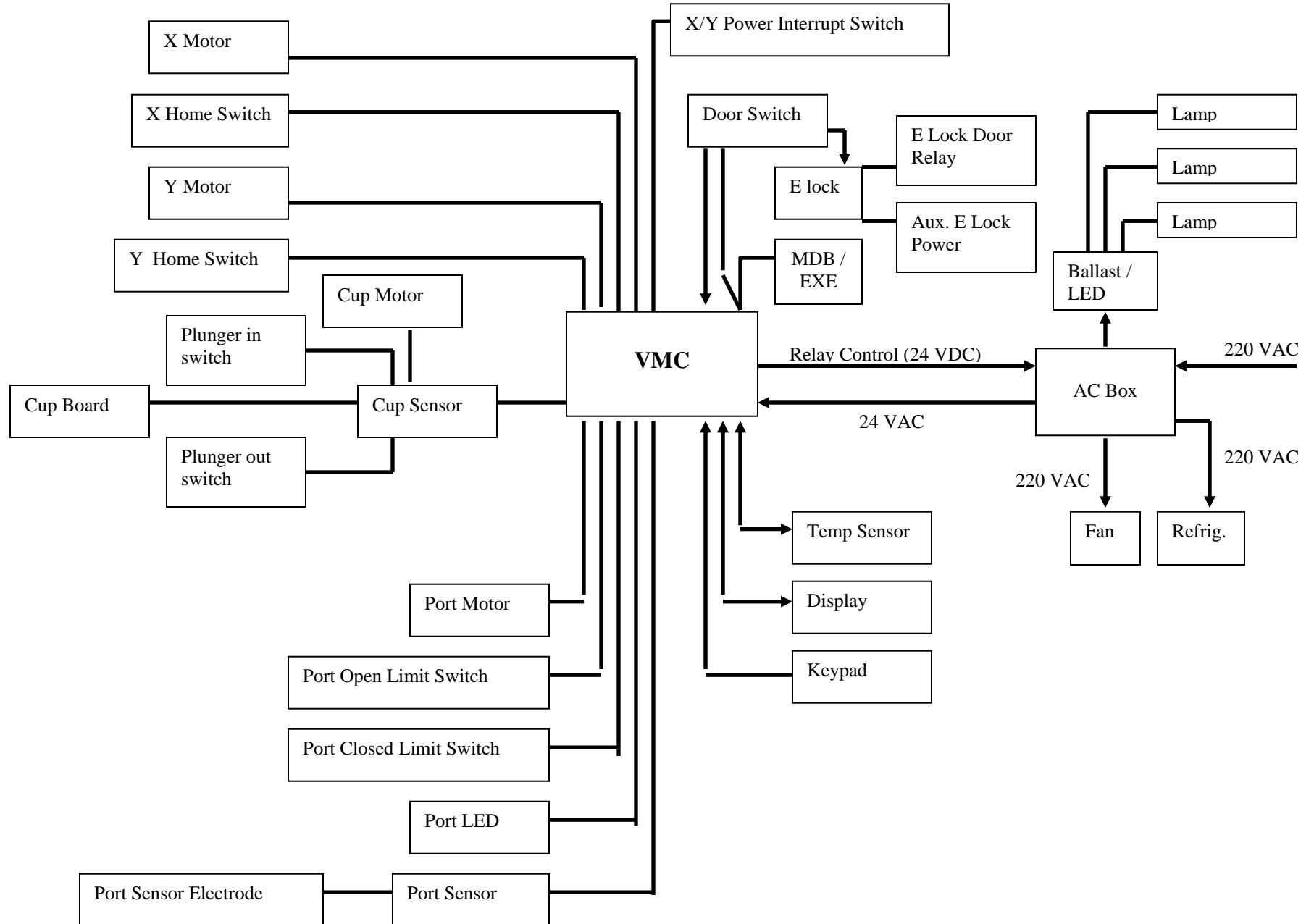

BevMax 4 5800-4/3800-4/5800-E4/3800-E4 Cabinet Diagram (Domestic & Export)

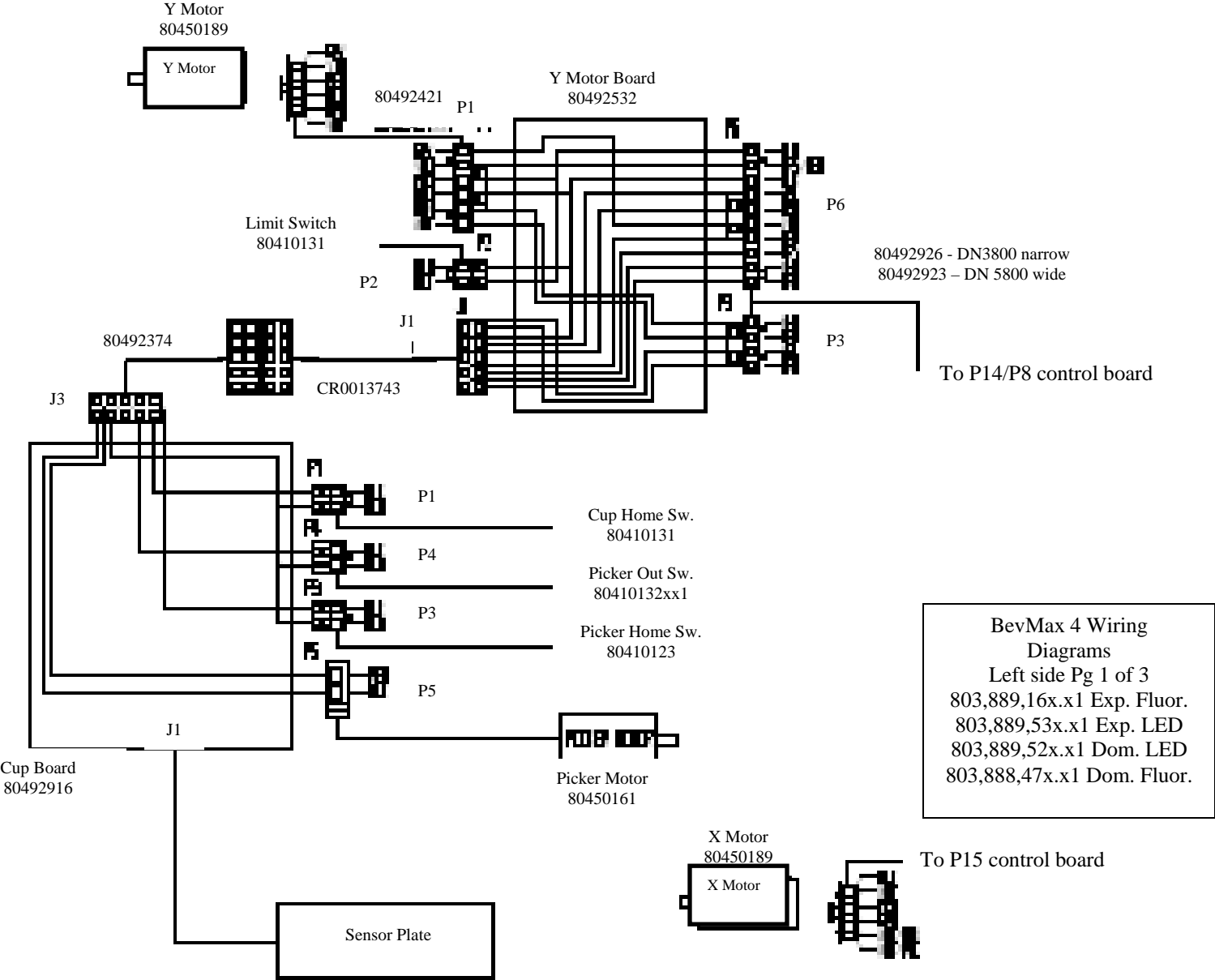

BevMax 4 Wiring Diagrams
 Left side Pg 1 of 3
 803,889,16x.x1 Exp. Fluor.
 803,889,53x.x1 Exp. LED
 803,889,52x.x1 Dom. LED
 803,888,47x.x1 Dom. Fluor.

BevMax 4 5800-4/3800-4/5800-E4/3800-E4 Cabinet Diagram (Domestic & Export)

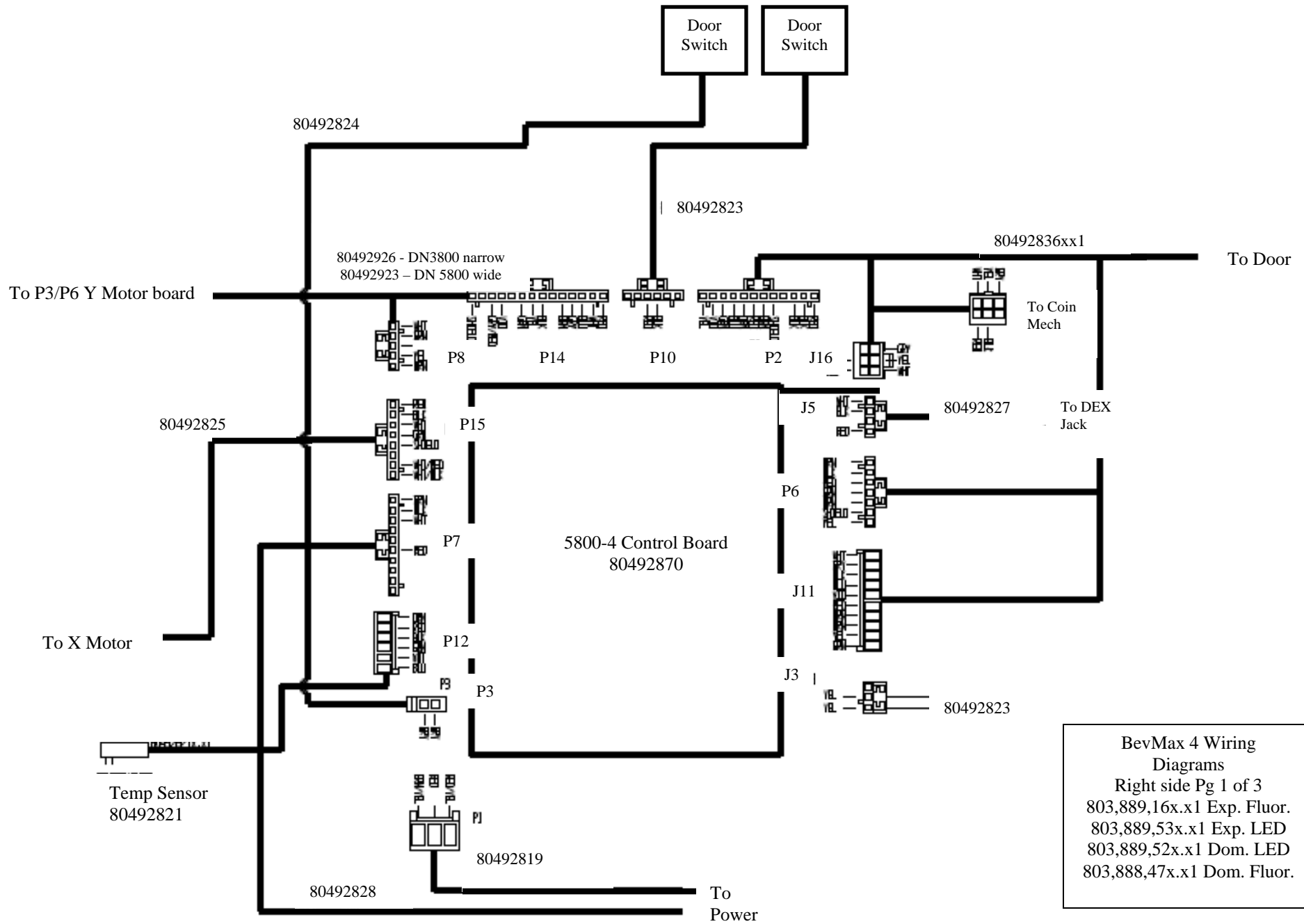

BevMax 4 Wiring
Diagrams
Right side Pg 1 of 3
803,889,16x.x1 Exp. Fluor.
803,889,53x.x1 Exp. LED
803,889,52x.x1 Dom. LED
803,888,47x.x1 Dom. Fluor.

BevMax 4 5800-4/3800-4/5800-E4/3800-E4 Door Diagram (Domestic & Export)

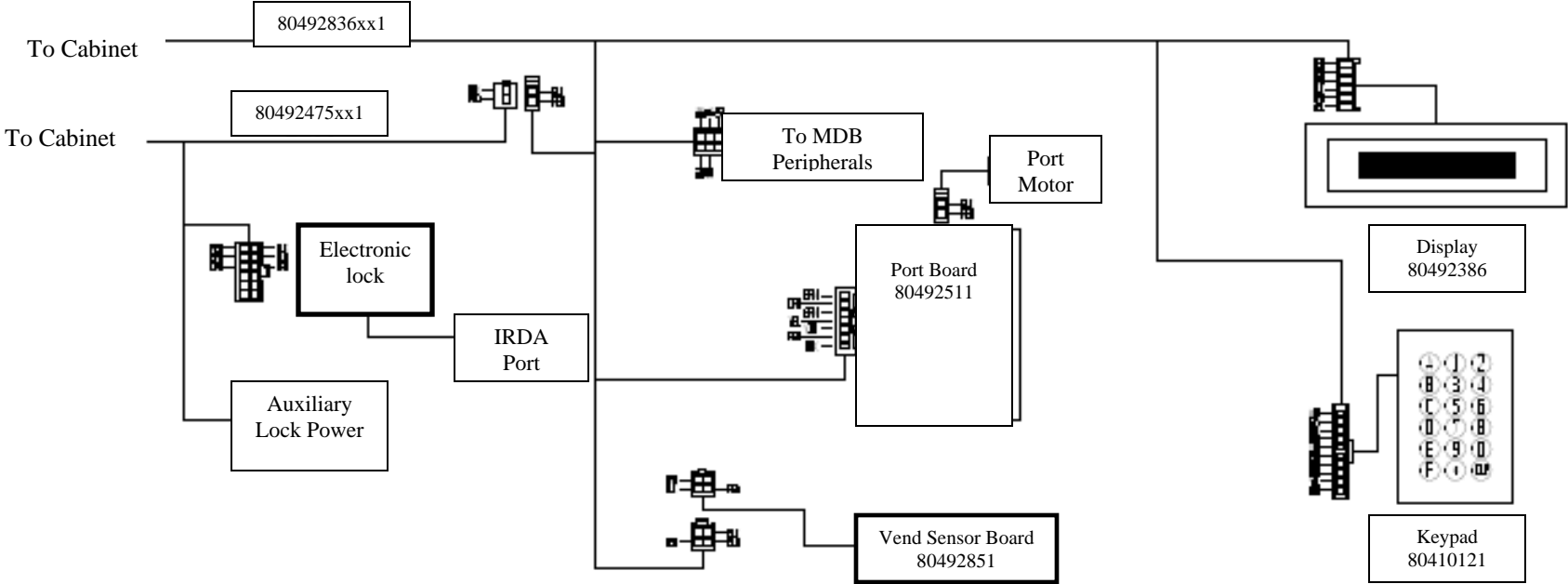

BevMax 4 Wiring
 Diagrams
 Pg 2 of 3
 803,889,16x.x1 Exp. Fluor.
 803,889,53x.x1 Exp. LED
 803,889,52x.x1 Dom. LED
 803,888,47x.x1 Dom. Fluor.

BevMax 4 5800-4/3800-4 Domestic Power & Fluorescent Lighting Diagram With JST Connectors

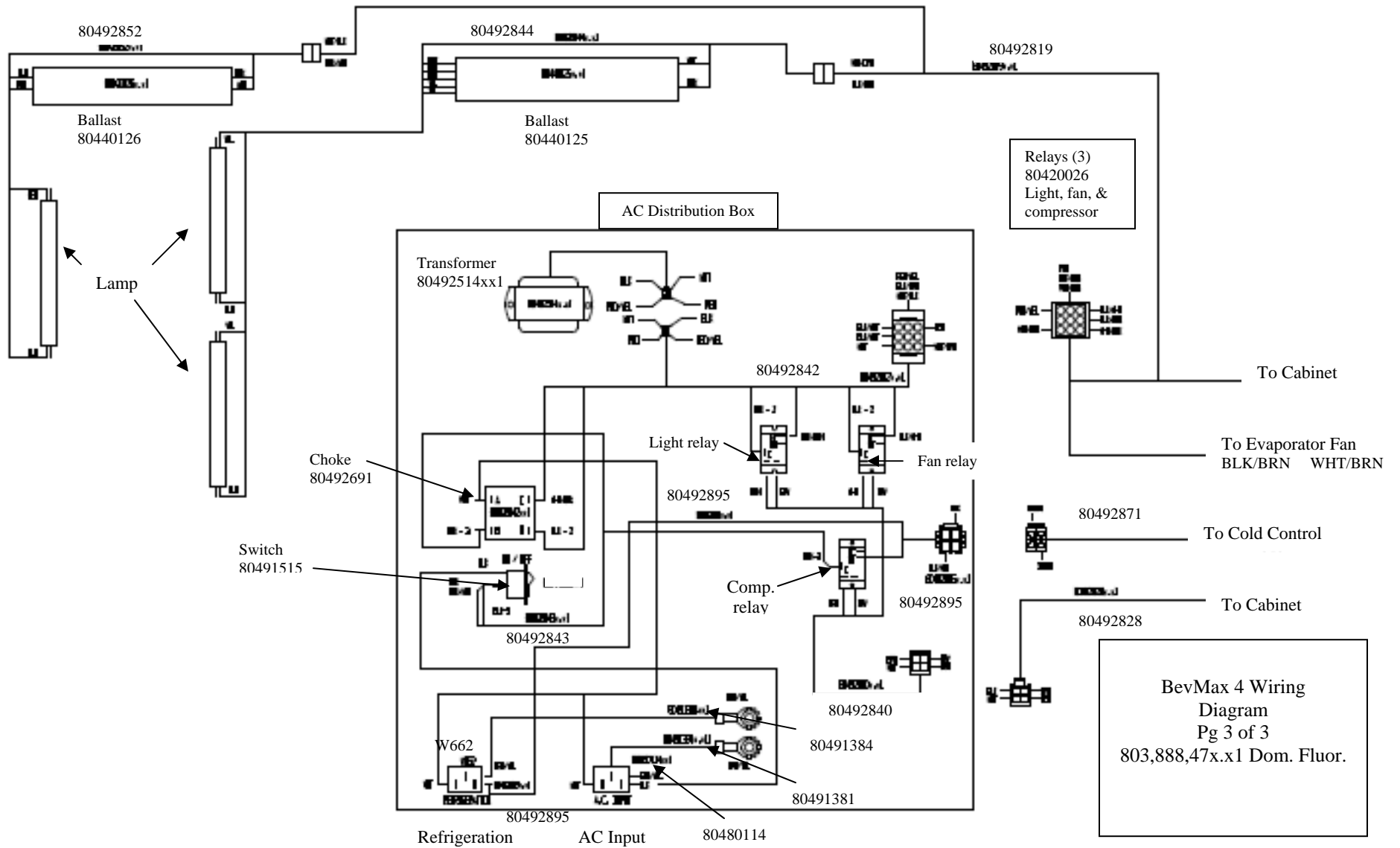

BevMax 4 5800-4/3800-4 Export Power & Fluorescent Lighting Diagram

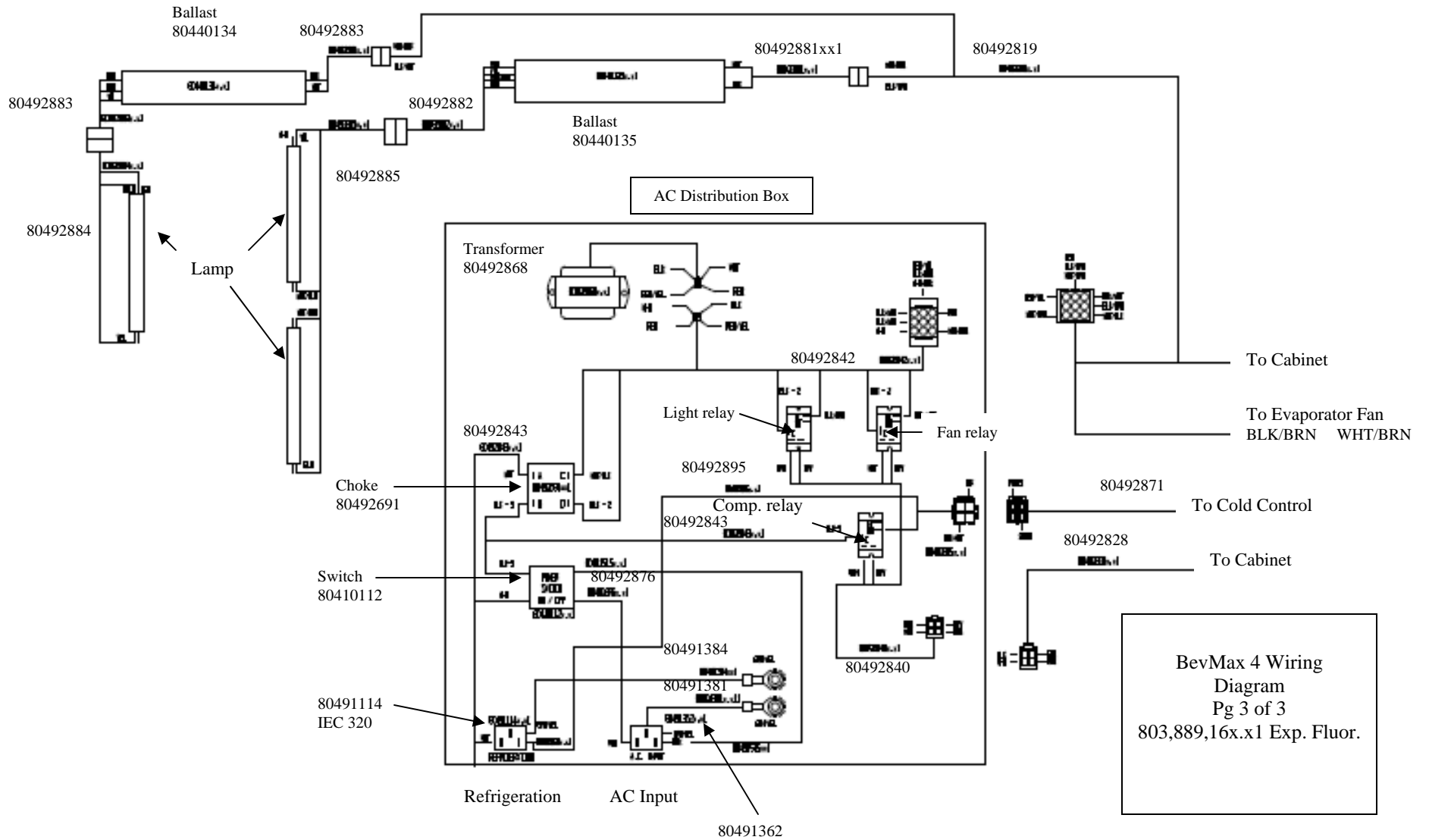

BevMax 4 5800-E4/3800-E4 Export Power & LED Lighting Diagram

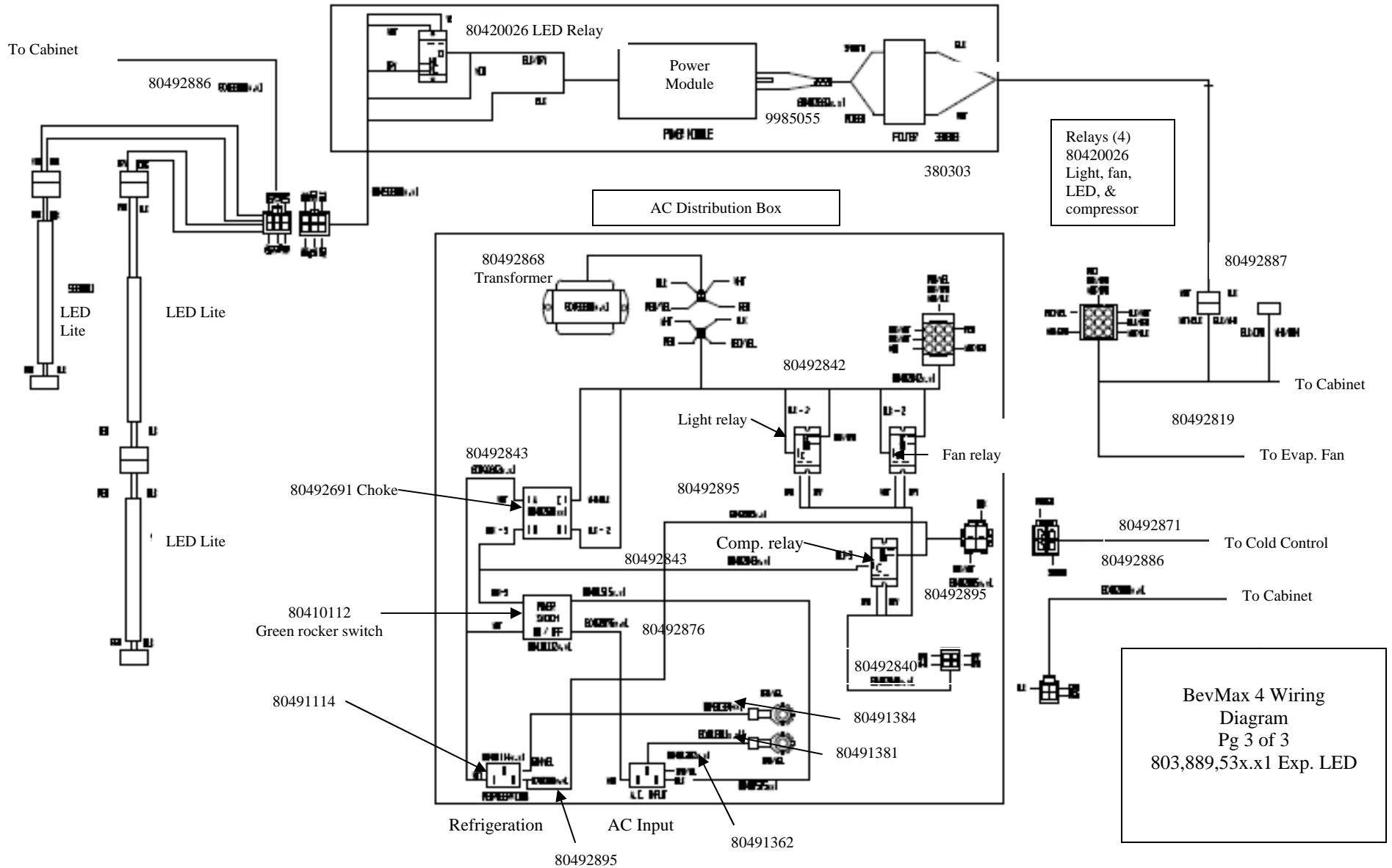

BevMax 4 Wiring
Diagram
Pg 3 of 3
803,889,53x.x1 Exp. LED

BevMax 4 5800-4/3800-4 Domestic Power & LED Lighting Diagram

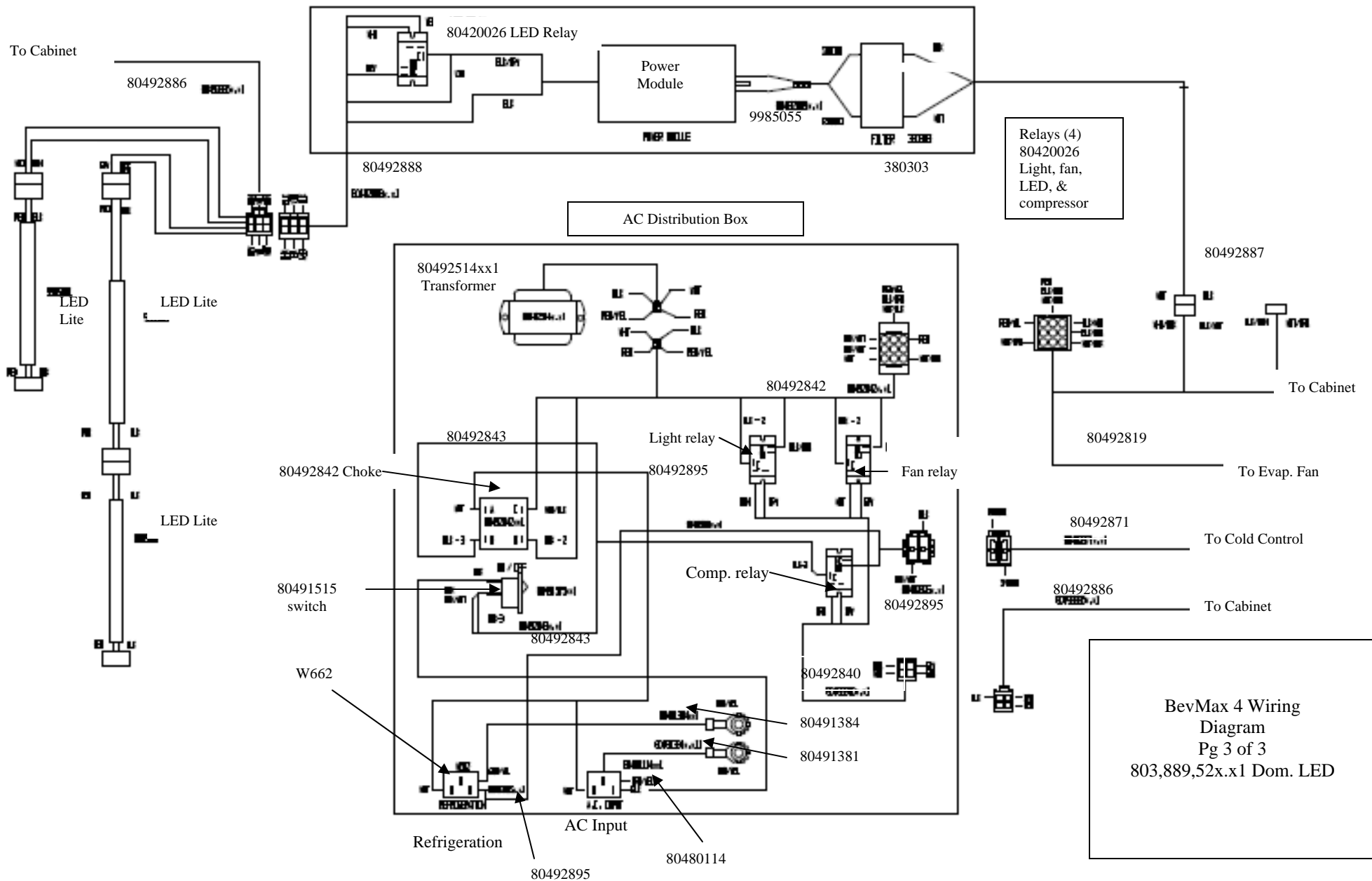

BevMax 4 5800-4/3800-4 Compressor Parts Diagram

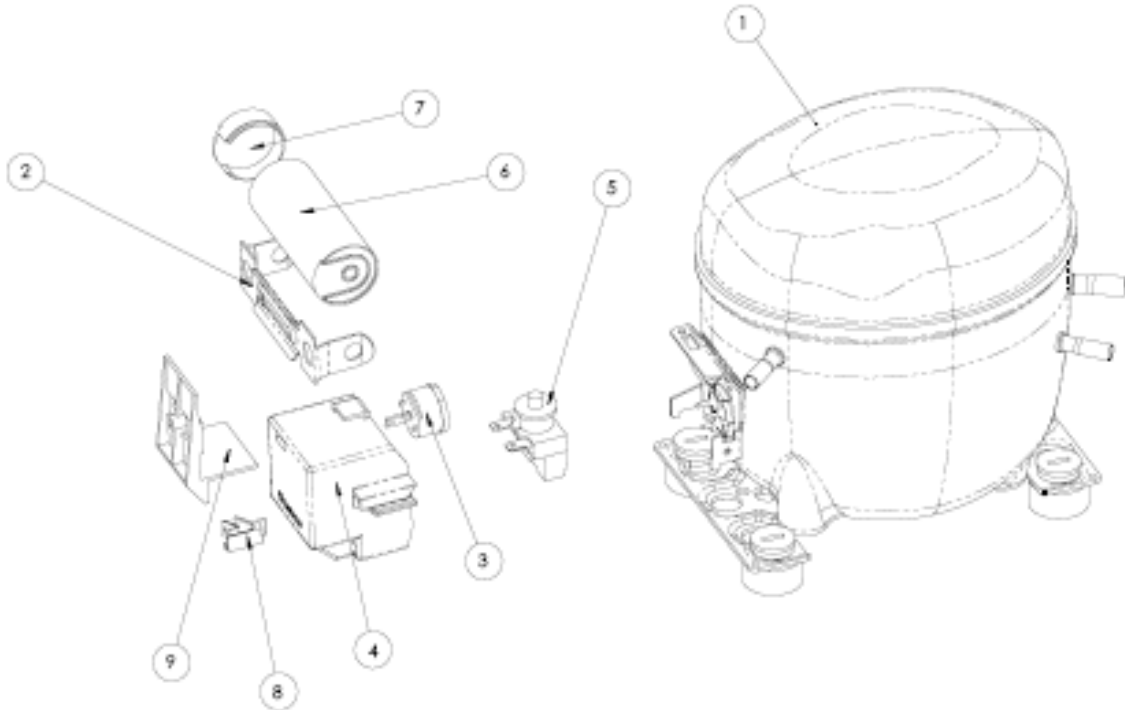

Domestic Compressor Parts BevMax 4 5800-4/3800-4 65701270 Domestic Refrigeration Kit

Item #	Part #	Description
1	80250289	Compressor, Embraco FFU130HAX 115/60 (EM# 513200620)
2	80240217	Bracket, Capacitor FFU130HAX (EM#US-2255008)
3	80240213	Overload, Compressor FFU130HAX (EM#513554617)
4	80240214	Cover, Electrical Component FFU130HAX (EM#13555028)
5	80240216	Relay, Compressor Start FFU130HAX (EM#213516051)
6	80240218	Capacitor, Compressor Start FFU130HAX (EM#US-3252378)
7	80240220	Cap, Capacitor FFU130HAX (EM#2254002)
8	80240215	Cord, Relief FFU130HAX (EM#513545045)
9	802,402,21x.x1	Holder Capacitor FFH130HAX (EM#513555135)
10	R134A	Freon (9.5oz or .269kg)

BevMax 4 5800-E4/3800-E4 Compressor Parts Diagram

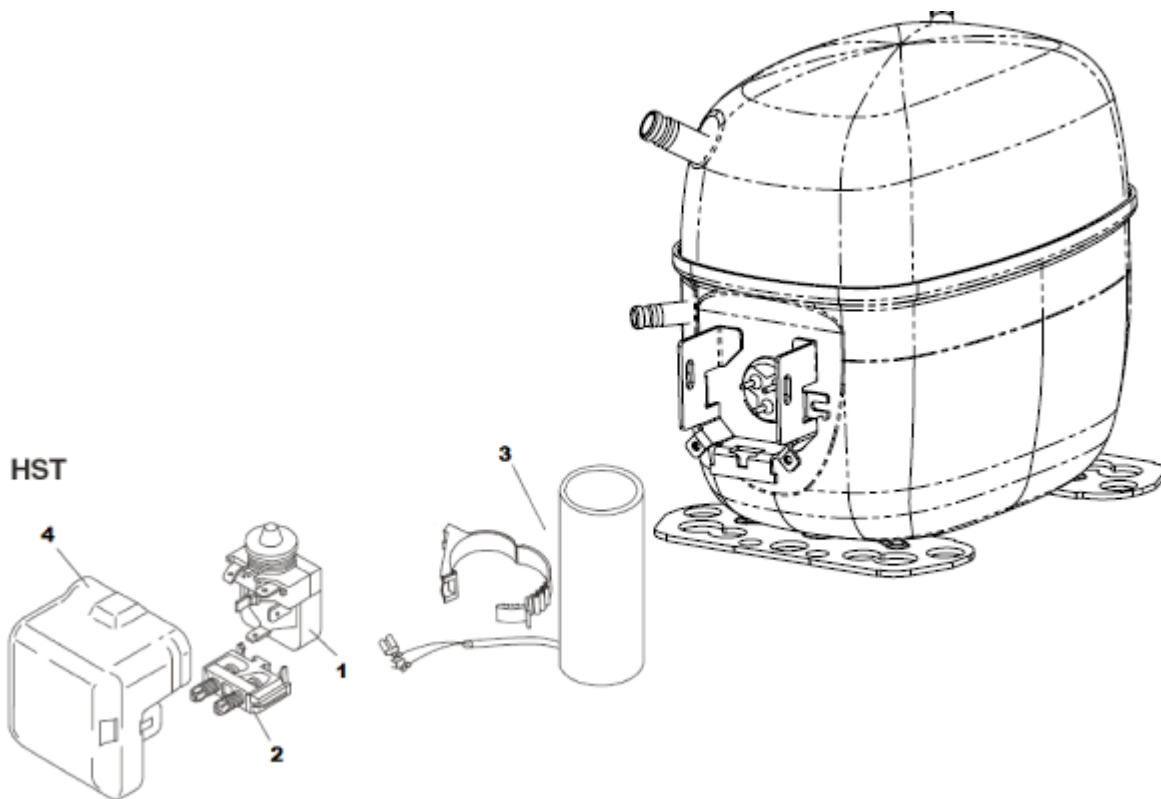

Export Compressor Parts BevMax 4 5800-E4/3800-E4 65701290 Export Refrigeration Kit

Item #	Part #	Description
	CR0004162	Compressor, Export
1	CR0004863	Starting Relay, Danfoss
2	CR0004865	Cord, Relief Compressor Danfoss
3	CR0004174	Capacitor, Compressor Start 80 μ F, Danfoss
4	CR0004172	Cover, Electrical Component FFU130HAX (EM#13555028)
5	R134A	Freon (9.5oz or .269kg)

BevMax 4 5800-4/3800-4 AC Distribution Box

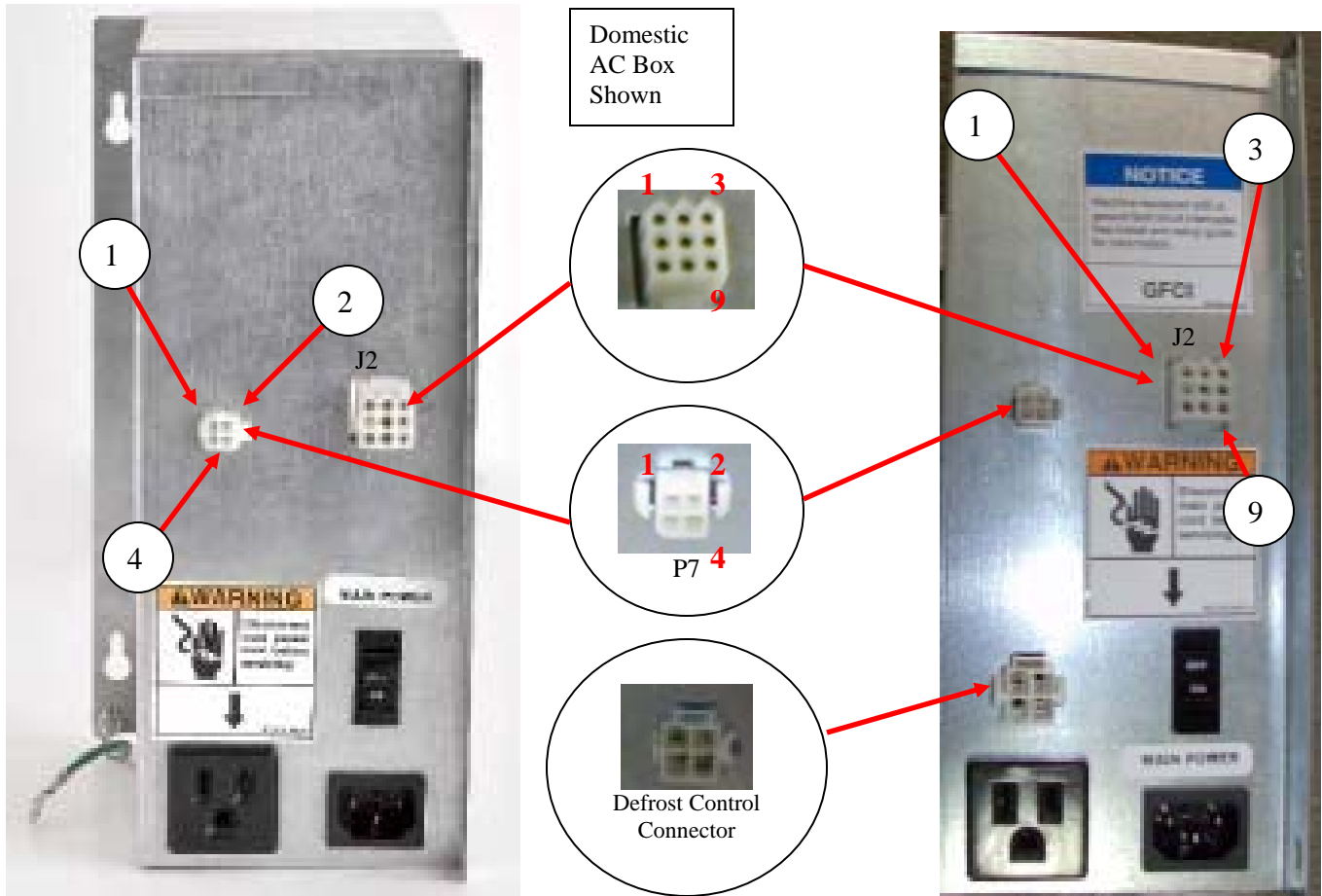

Domestic Test Voltages 9 Pin J2 Output Power Connector		
1 st lead to Pin	2 nd lead to	Domestic Reading
1	2	24 (26 to 30) VAC secondary of transformer
2	1	24 (26 to 30) VAC secondary of transformer
3	ground	110 VAC Hot not switched for 1 lamp assy.
4	NA	OPEN
5	ground	115 VAC Hot switched for fan motor
6	ground	115 VAC Hot switched for lights
7	ground	0 VAC Neutral
8	ground	0 VAC Neutral
9	ground	0 VAC Neutral

Domestic Test Measurements 4 Pin P7 AC Distribution Box			
1 st lead to Pin	2 nd lead to Pin	Domestic Reading	When 4 pin connector is unplugged – OHMS reading
1	3	Lights control relay coil	570 ohms
2	3	Fan control relay coil	570 ohms
4	3	Compressor relay coil	570 ohms
3	NA	Common	NA

Export BevMax 4 5800-E4/3800-E4 AC Distribution Box

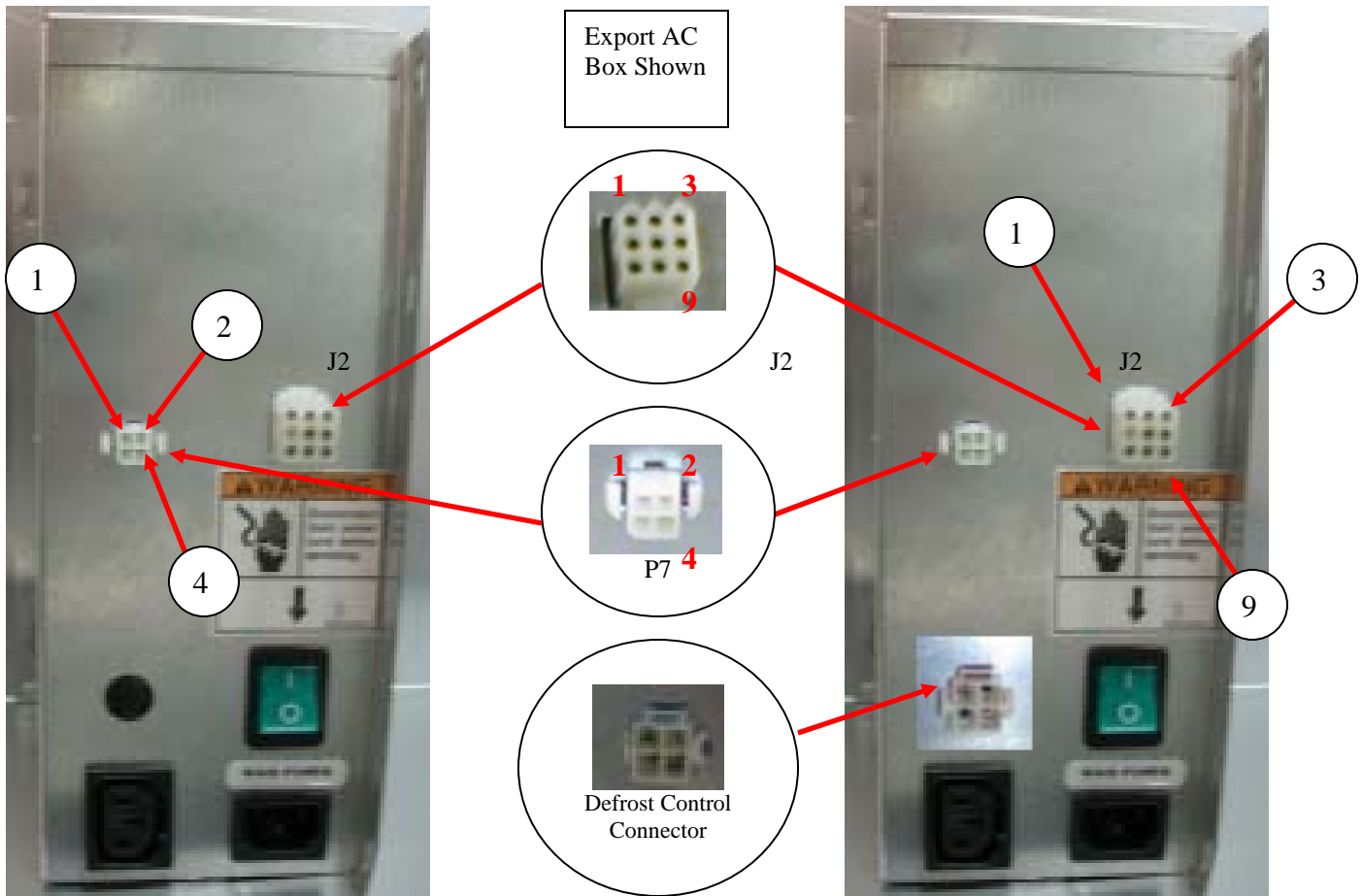

Export Test Voltages 9 Pin J2 Output Power Connector		
1 st lead to Pin	2 nd lead to	Export Reading
1	2	24 (26 to 30) VAC secondary of transformer
2	1	24 (26 to 30) VAC secondary of transformer
3	ground	240 VAC Hot not switched for 1 lamp assy.
4	NA	OPEN
5	ground	240 VAC Hot switched for fan motor
6	ground	240 VAC Hot switched for lights
7	ground	0 VAC Neutral
8	ground	0 VAC Neutral
9	ground	0 VAC Neutral

Export Test Measurements 4 Pin P7 AC Distribution Box			
1 st lead to Pin	2 nd lead to Pin	Export Reading	When 4 pin connector is unplugged – OHMS reading
1	3	Lights control relay coil	570 ohms
2	3	Fan control relay coil	570 ohms
4	3	Compressor relay coil	570 ohms
3	NA	Common	NA

PARTS LIST

PARTS LIST AND DIAGRAMS	67 – 102
Machine Front View	69 – 70
Cabinet Detail Product Area	71 – 72
Cabinet Detail Service Door Area	73 - 74
XY Motor Picker Unit.....	75 – 76
Picker Cup Assembly.....	77 – 78
Service Door Outside.....	79 – 80
Service Door Inside.....	81 – 82
Gate Tray Detail	83 – 88
AC Distribution Box	88 - 86
Lighting - Fluorescent.....	87
Lighting - LED	88
Refrigeration Unit Fin & Tube Condenser w/ Plastic Evap Box.....	89 – 90
Refrigeration Unit Fin & Tube Condenser w/ Metal Evap Box.....	91 – 92
Electronics.....	93 - 94
Harnesses	95 – 96
Labels / Decals / Misc.	97 - 98
Screws & Nuts.....	99 – 100
Washers, Bolts, & Misc. Hardware	101 – 102

Special Note: Crane Merchandising Systems Dixie-Narco part numbering has changed. Many of the 11 digit numbers are now 8 digit numbers. The last 3 digits were dropped in the new numbering system. An example of this is 800,102,970.01 is now 80010297.

MACHINE FRONT VIEW

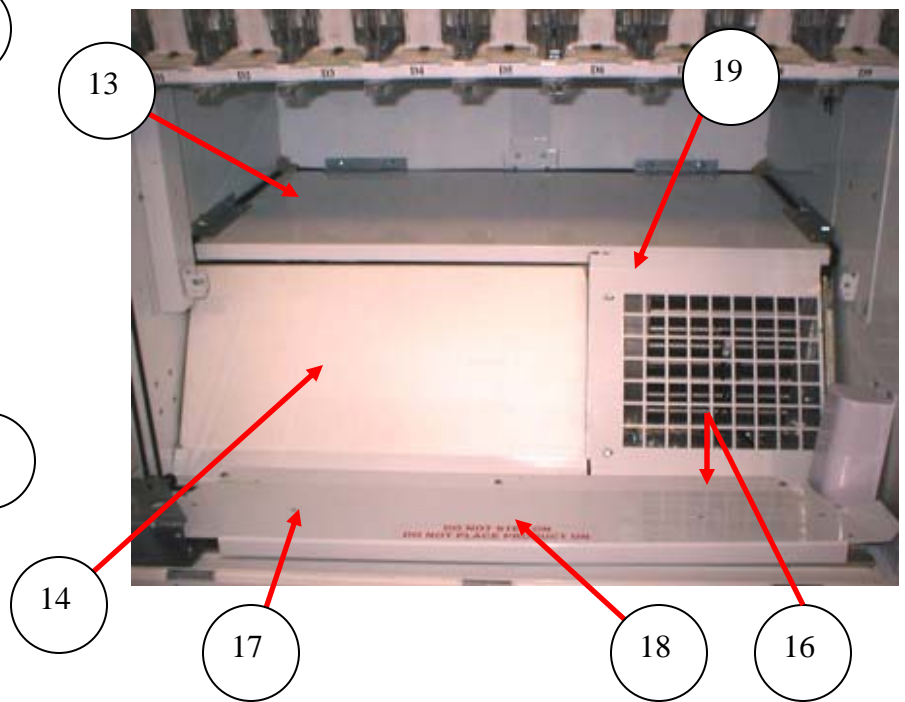
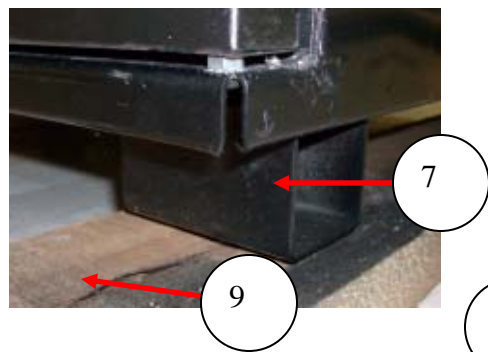
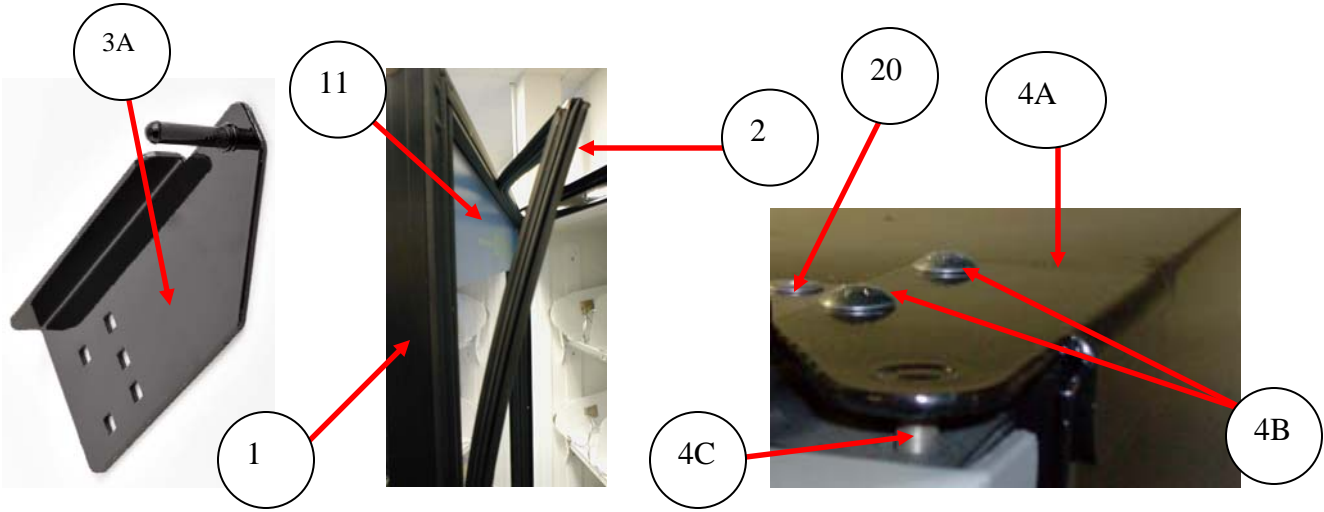
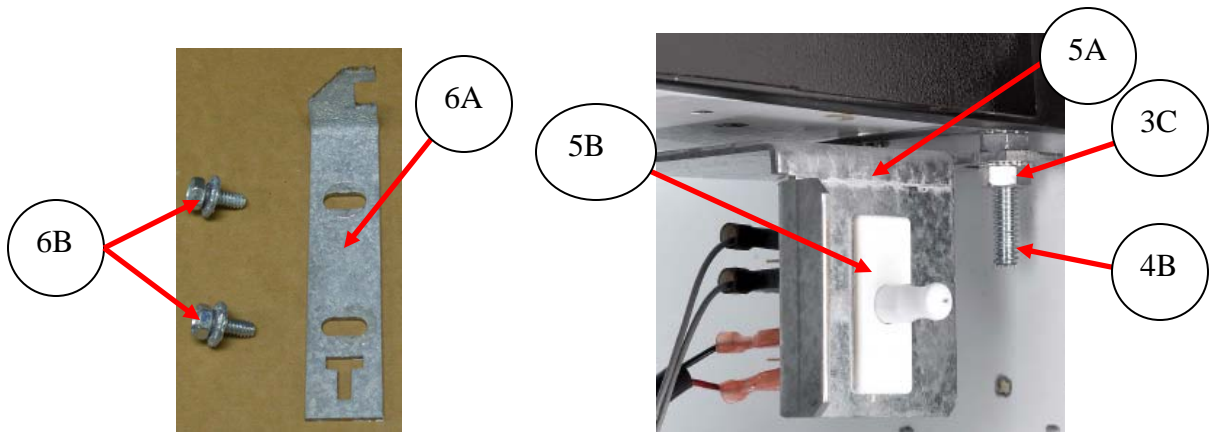

MACHINE FRONT VIEW

ITEM	PART DESCRIPTION	DN5800-4 DN5800-E4	DN3800-4 DN3800-E4
1	Door Assembly, Glass (does not include decals)	80010595	80010596
2	Gasket, Glass Door	80010297	80010298
3A	Top Hinge Glass Door	65700036	Same
3B	Carriage Bolt – ¼ - 20 x 1 1/4	80020243	Same
3C	Hex Nut – ¼ - 20	80080157	Same
3D	Washer, Flat	80070144	Same
3E	Screw, Torx 8 X 5/8 (nib size TRX27)	48909108	Same
	Screw, Fl. Torx Tap ¼-20 X ½	AP13100035	Same
	Screw, Hex 8 X 5/8	80030468	Same
4A	Top Hinge Service Door	CR0002256	Same
4B	Carriage Bolt, 1/4 –20 X 2.5” (also service door bottom hinge pin)	80020249	Same
4C	Top Hinge Pin, Service Door	CR0002219	Same
4D	Lock Nut, Service Door Hinge Pin Bolt ¼ - 20	80030478	Same
4E	Washer, Service Door Hinge Pin	900,701,19x.x1	Same
5A	Door Switch Bracket – Single Switch	64700105	Same
	Door Switch Bracket – Double Switch (electronic lock venders only)	64700104	Same
5B	Power Interrupt Switch	80410059	Same
5C	Lock Switch .1Amp (electronic lock venders only)	804,101,19x.x1	Same
6A	Door Latch High Security, 2 Point Lock	CR0010839	Same
6B	Screw, Hex ¼ - 20 x 5/8	80030436	Same
7	Leg Assembly, welded in place	65700060	Same
8	Leg Leveler, 5/8 – 11 x 2 1/16	80050379	Same
9	Shipping Boards, Domestic	CR0000969	Same
	Shipping Boards, Export	CR0004959	Same
10	Thermometer	80140155	Same
11	Wear Strip Door Decal	80387837	Same
12	Glass Door Bottom Hinge	65700035	Same
13	Bottom Panel Assembly	CR0004713	CR0004585
14	Assembly Panel Slanted, with plastic evap box Refrig unit	CR0007060	CR0007064
	Assembly Panel Slanted with metal evap box Refrig unit	CR0004787	CR0004853
15	Door Stop	64700045	Same
16	Wire Chase Assembly	CR0004882	CR0004884
17	Ramp	CR0002585	65707007
18	Warning Label, Ramp	80388543	Same
19	Evaporator Inlet Grill	CR0002388	Same
20			

Part numbers & descriptions are subject to change with out notice.
 NA = Not applicable TBD = To be determined RB = Replaced by

CABINET DETAIL PRODUCT AREA

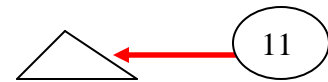
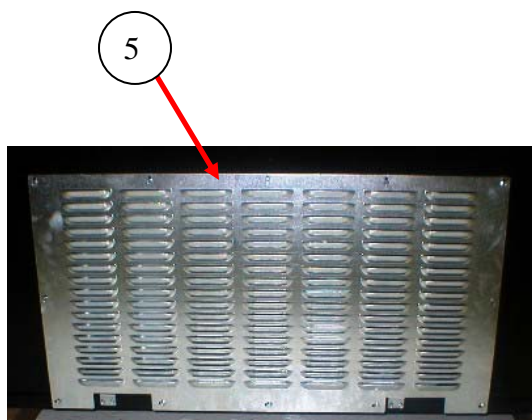
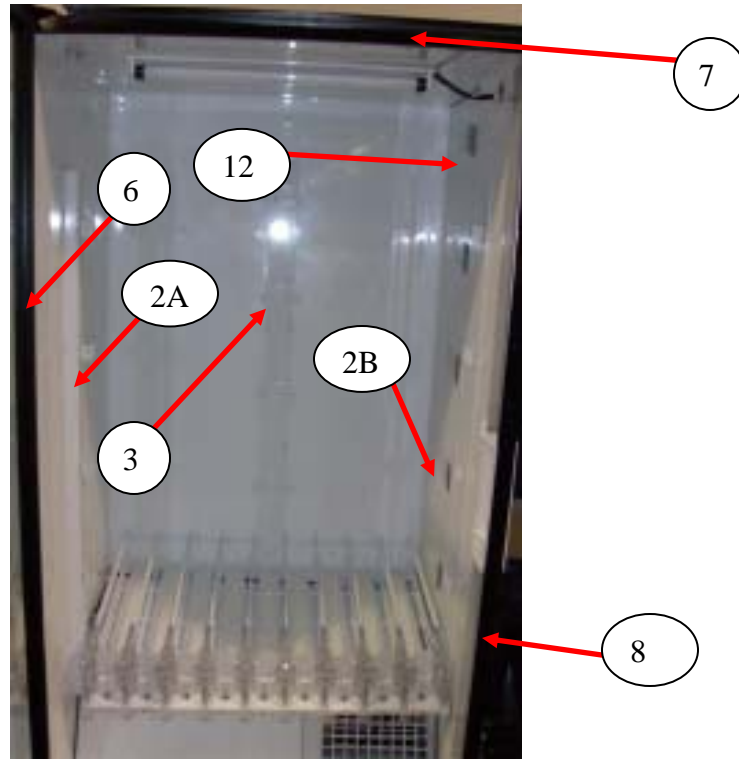

CABINET DETAIL PRODUCT AREA

ITEM	PART DESCRIPTION	DN5800-4 DN5800-E4	DN3800-4 DN3800-E4
1	Cabinet Assembly, Generic	65706020	CR0002684
2A	Left Tray Mount Bracket, 2 piece prior to 9133DH (All)	64707005	Same
	Left Tray Rail, 2 piece (5 shelf) prior to 9133DH (E4)	657,070,03x.x3	Same
	Left Tray Rail, 2 piece (5 shelf) prior to 9133DH (Export)	CR0004428	Same
	Left Tray Rail, 2 piece (5 shelf) prior to 9133DH – E6	CR0008227	Same
	Left Tray Support, 1 piece (5 shelf) 9133DH & higher - E3	CR0006968	Same
	Left Tray Support, 1 piece (5 shelf) 9133DH & higher - E4	CR0006970	Same
	Left Tray Support, 1 piece (5 shelf) 9133DH & higher - E5	CR0007230	Same
	Left Tray Support, 1 piece (5 shelf) 9133DH & higher – E6	CR0008225	Same
	Left Tray Support, 1 piece (5 shelf) 9133DH & higher - D2	CR0005592	Same
2B	Right Tray Mount Bracket, 2 piece prior to 9133DH (All)	64707004	Same
	Right Tray Rail, 2 piece (5 shelf) – E4	65707001	Same
	Right Tray Rail, 2 piece (5 shelf) prior to 9133DH (Export)	CR0004449	Same
	Right Tray Rail, 2 piece (5 shelf) prior to 9133DH – E6	CR0008228	Same
	Right Tray Support, 1 piece (5 shelf) 9133DH & higher - E3	CR0006967	Same
	Right Tray Support, 1 piece (5 shelf) 9133DH & higher - E4	CR0006971	Same
	Right Tray Support, 1 piece (5 shelf) 9133DH & higher - E5	CR0007231	Same
	Right Tray Support, 1 piece (5 shelf) 9133DH & higher – E6	CR0008224	Same
	Right Tray Support, 1 piece (5 shelf) 9133DH & higher - D2	CR0005593	Same
3	Rear Tray Mount Bracket, 2 piece prior to 9133DH (All)	64707003	Same
	Rear Tray Rail, 2 piece (5 shelf) – E4	65707002	Same
	Rear Tray Rail, 2 piece (5 shelf) prior to 9133DH (Export)	CR0004447	Same
	Rear Tray Support, 1 piece (5 shelf) 9133DH & higher - E3	CR0006969	Same
	Rear Tray Support, 1 piece (5 shelf) 9133DH & higher - E4	CR0006972	Same
	Rear Tray Support, 1 piece (5 shelf) 9133DH & higher - E5	CR0007232	Same
	Rear Tray Support, 1 piece (5 shelf) 9133DH & higher – E6	CR0008226	Same
	Rear Tray Support, 1 piece (5 shelf) 9133DH & higher - D2	CR0005594	Same
4a	Tray Support Screw #8-18x1/2 Phil Pan (Self drilling, 9 per rail)	80030418	Same
4b	Hex Washer Screw (2 per shelf)	80030468	Same
5	Ingress Guard (was CR0001245)	CR0007657	Same
	Ingress Guard with Screen Export	CR0005110	Same
	Modified Rodent Guard Assy (use with CR0005110)	CR0005102	Same
6	Security Angle, Left was 64706007	CR0000953	Same
7	Security Angle, Top	65700026	CR0002770
8	Security Angle, Right	CR0000954	Same
9	Assembly Discharge Frame	80181994	Same
10	Discharge Door Magnet	80410105	Same
11	Discharge Port Diverter	CR0007420	Same
12	Louver Panel Assembly	CR0004574	Same
13	Defrost Control Mounting Bracket	64704003	Same
14	Defrost Control Cover	CR0004136	Same
15	Defrost Control Vinyl Tube	80190275	Same
16	Mesh Inlet Screen Assembly (near unit handle) - Export	CR0005112	Same

Part numbers & descriptions are subject to change with out notice.
 NA = Not applicable TBD = To be determined RB = Replaced by

CABINET DETAIL SERVICE DOOR AREA

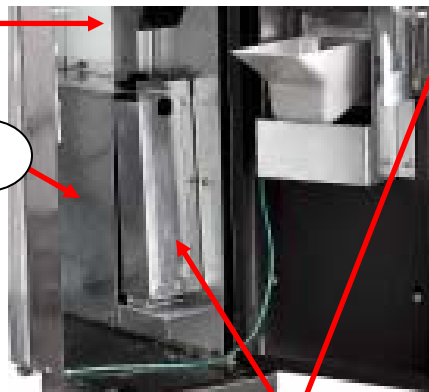
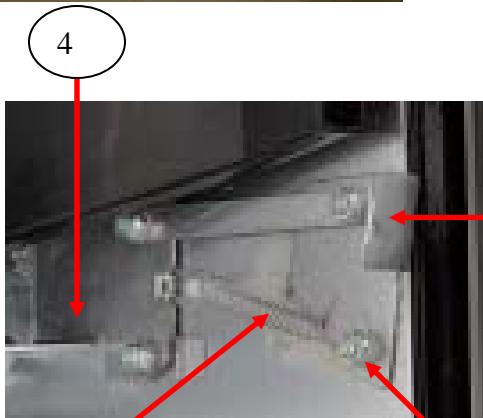
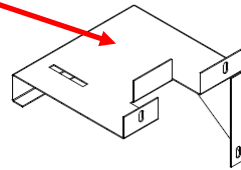
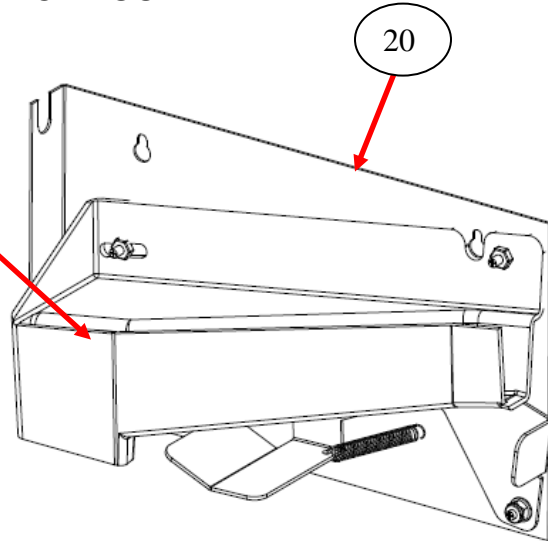
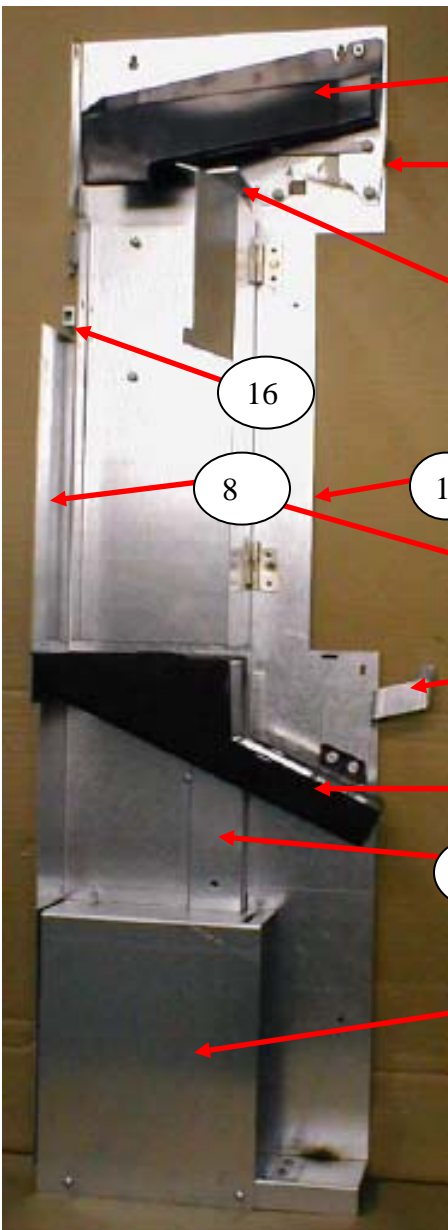

XY MOTOR PICKER UNIT

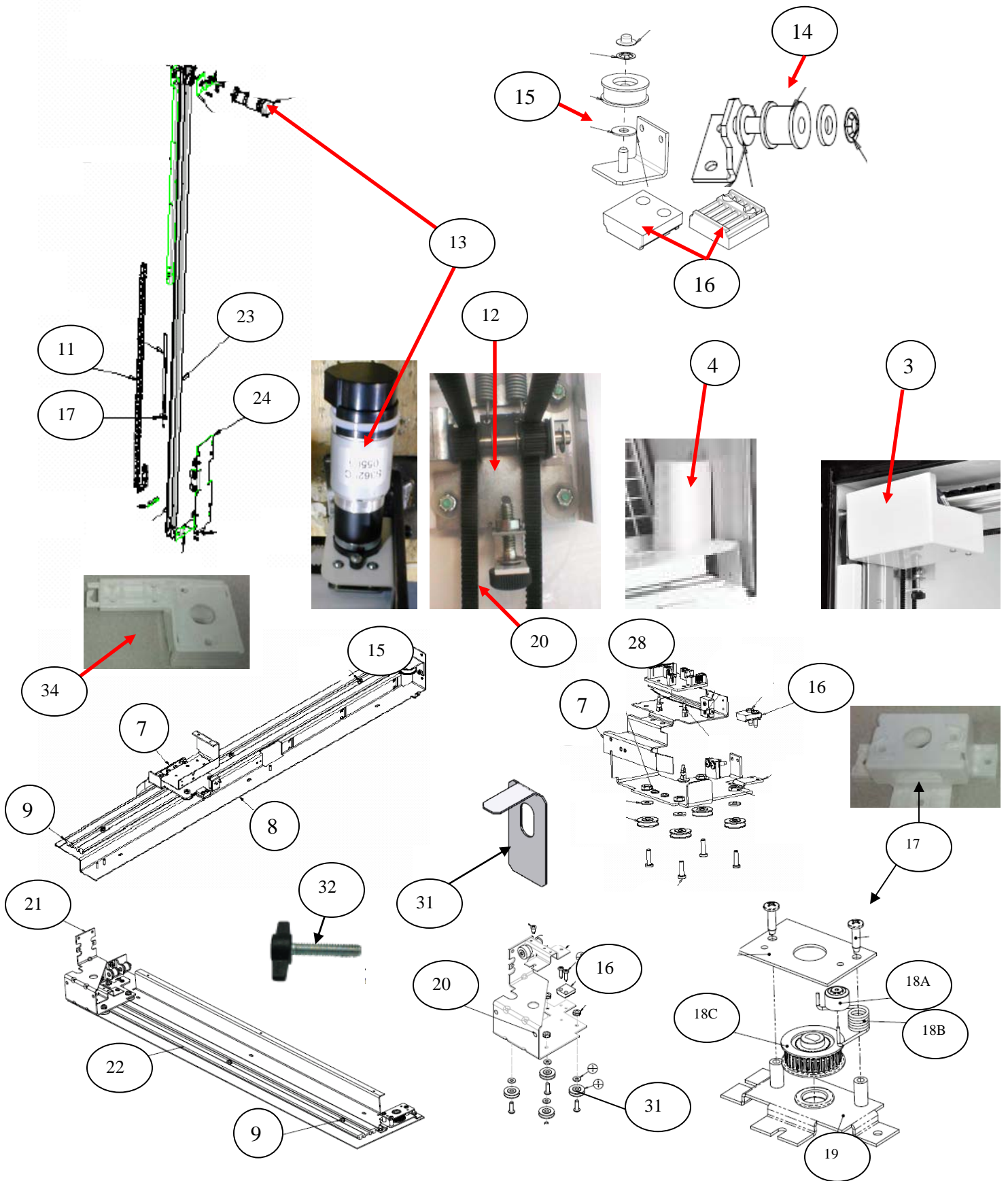

XY MOTOR PICKER UNIT

ITEM	PART DESCRIPTION	DN5800-4 DN5800-E4	DN3800-4 DN3800-E4
1	XY Delivery System	CR0002183	CR00027472
2	Assembly Cover Y Belt	CR0001797	Same
3	Y Motor Cover Top	80182329	Same
4	X Motor Cover Bottom	80182328	Same
5	X Bottom Belt Cover (Ramp)	CR0002585	65707007
6	Harness, X Motor – bottom, not shown	80492825	Same
7	X Top Carriage Assembly (top of XY)	CR0002121	Same
8	X Axis Mounting Assembly Top	CR0002133	CR0002736
9	XY Extrusion (X track)	80120188	80120208
10	Harness, XY E Chain (Top horizontal) – not shown	80492826	80492894
11	Harness, Y E Chain (vertical) was 80492479	CR0013743	Same
12	XY Belt Idler Tensioning Assembly (top left)	64707970	Same
13	Motor XY System (Large D shaft) was 80450184	80450189	Same
14	Idler Pulley and Bracket Assembly	64708160	Same
15	X Top Idler Pulley Assembly	64708110	Same
16	Belt Clamp	80510003	Same
17	X Pulley Drive Assembly was 647,084,70x.x3	CR0006104	Same
18A	Oilite Bushing no longer available	NA	NA
18B	Tension Spring used in 647,084,70x.x3 only	801,701,71x.x1	Same
18C	Pulley, 32 tooth “D” Drive	80530066	Same
19	X Motor Bracket Assembly was 647,084,60x.x3	CR0006104	Same
	X Motor Bracket Cover was 64707148	NA	Same
20	X Axis Belt (22’)	64707530	Same
21	X Bottom Carriage Assembly (bottom of XY)	64708240	Same
22	Assembly X Axis Drive, Bottom	64707930	CR0002741
23	Assembly Y Axis	CR0002127	Same
24	Y Carriage Assembly	64708220	Same
25	Y Axis Belt (11.25’)	65700200	80510006
26	Screw Hex ¼ - 28 x .5	80020284	Same
	Spacer, .257”	80530071	Same
	Hex Nut, ¼ - 28	CR0004998	Same
27	Micro Switch with Straight Arm (X Home)	80410131	Same
28	Y Board	80492532	Same
29	Y Extrusion	80120207	Same
30	Pulley Roller	80530054	Same
31	XY Shipping Bracket	64707109	Same
32	Screw, Wing ¼ - 20 x 1 ¼ molded nylon (for shipping bracket)	80030529	Same
33	Belt Tensioner Spring (Y Belt only)	80140197	Same
34	Y Pulley Drive Assy.	CR0005937	Same

Part numbers & descriptions are subject to change with out notice.
 NA = Not applicable TBD = To be determined RB = Replaced by

DELIVERY (PICKER) CUP ASSEMBLY

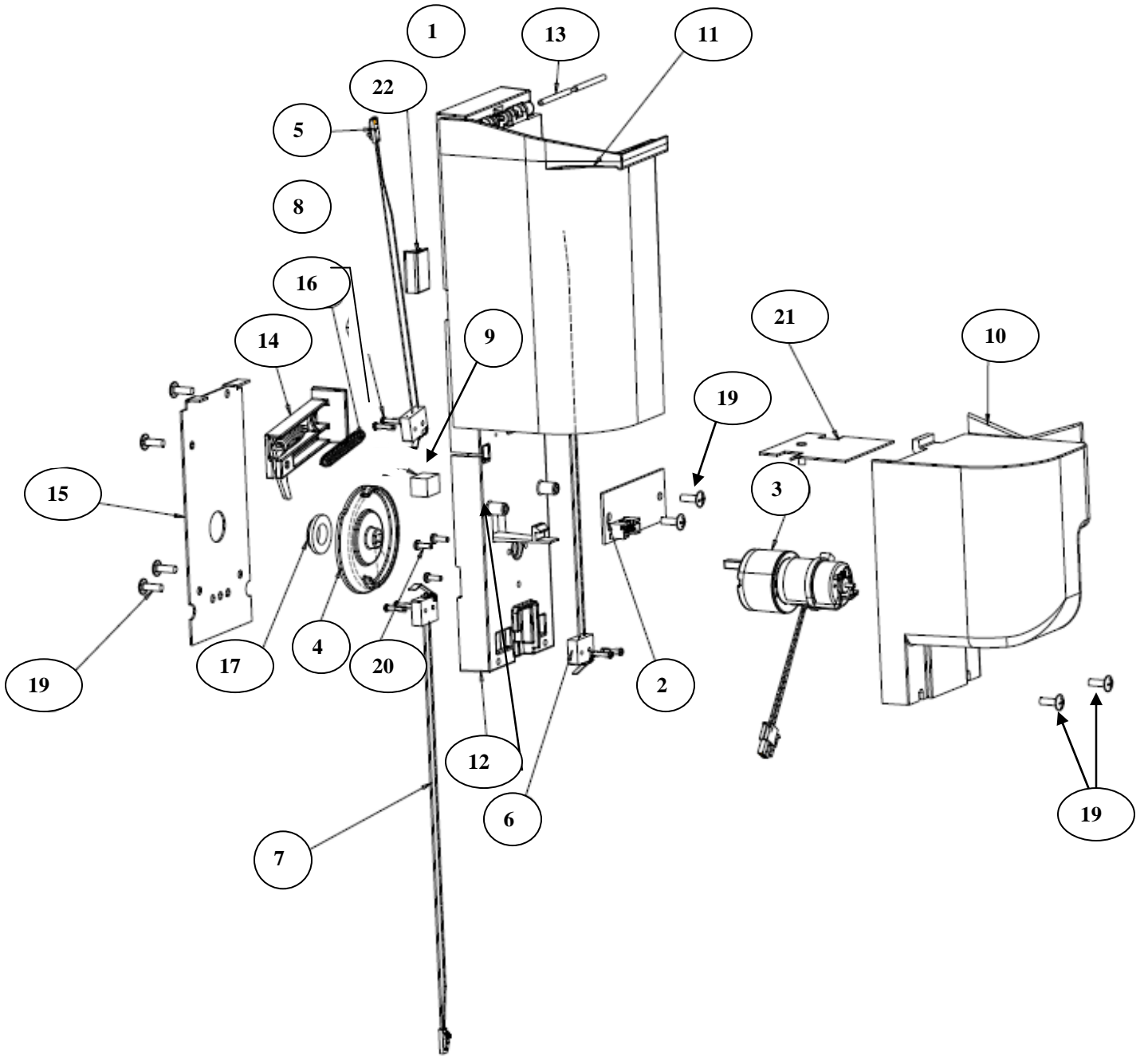

DELIVERY (PICKER) CUP ASSEMBLY

ITEM	PART DESCRIPTION	DN5800-4 DN5800-E4	DN3800-4 DN3800-E4
1	Assembly Delivery (Picker) Cup Assembly w/ Sensor was 64708270	80182497	Same
2	Cup Base Board (Picker Cup Board with sensor) 3/26/08 & after was 80492765	80492916	Same
3	Cup/Port Motor Assembly	80450161	Same
4	Cup Motor Cam	80120202	Same
5	Micro Switch with Bent Arm (Picker Home Switch)	80410137	Same
6	Micro Switch with Straight Arm (Cup Home Switch – Y)	80410135	Same
7	Micro Switch with Bent Arm (Picker Out Switch)	80410136	Same
8	Screw, Phil Pan 2 – 32 X 1/2	80030501	Same
9	Plunger Cup Bumper	80360123	Same
10	Base Cup Cover	80182289	Same
11	Delivery Cup Sleeve	80182258	Same
12	Delivery Cup Body	80182288	Same
13	Pin Cup Hinge	80120187	Same
14	Assembly Plunger	80520275	Same
15	Motor Cam Cover	64707035	Same
16	Return Spring, Plunger (Picker Cup)	80170167	Same
17	Cam Bearing	80530051	Same
18	Harness, Cup to E Chain	80492374	Same
19	Screw, 8 – 18 x 1/2 Pan Head, Machine	80030431	Same
20	Screw, #4 – 40 x 3/8 Machine w/ lock washer	80030503	Same
21	Cup Sensor Plate (3/26/08 & after)	64708090	Same
22	Flat Wire Clip	80181929	Same
23			
24			
Part numbers & descriptions are subject to change with out notice. NA = Not applicable TBD = To be determined RB = Replaced by			

SERVICE DOOR (OUTSIDE)

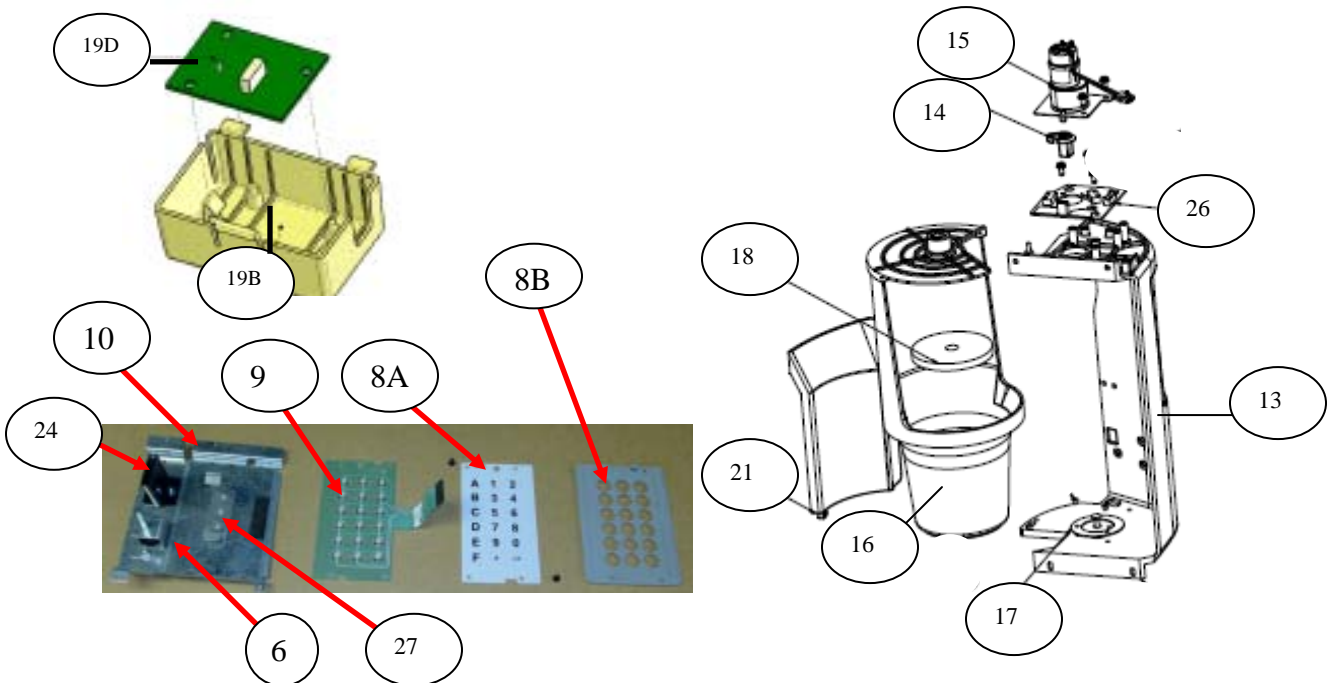
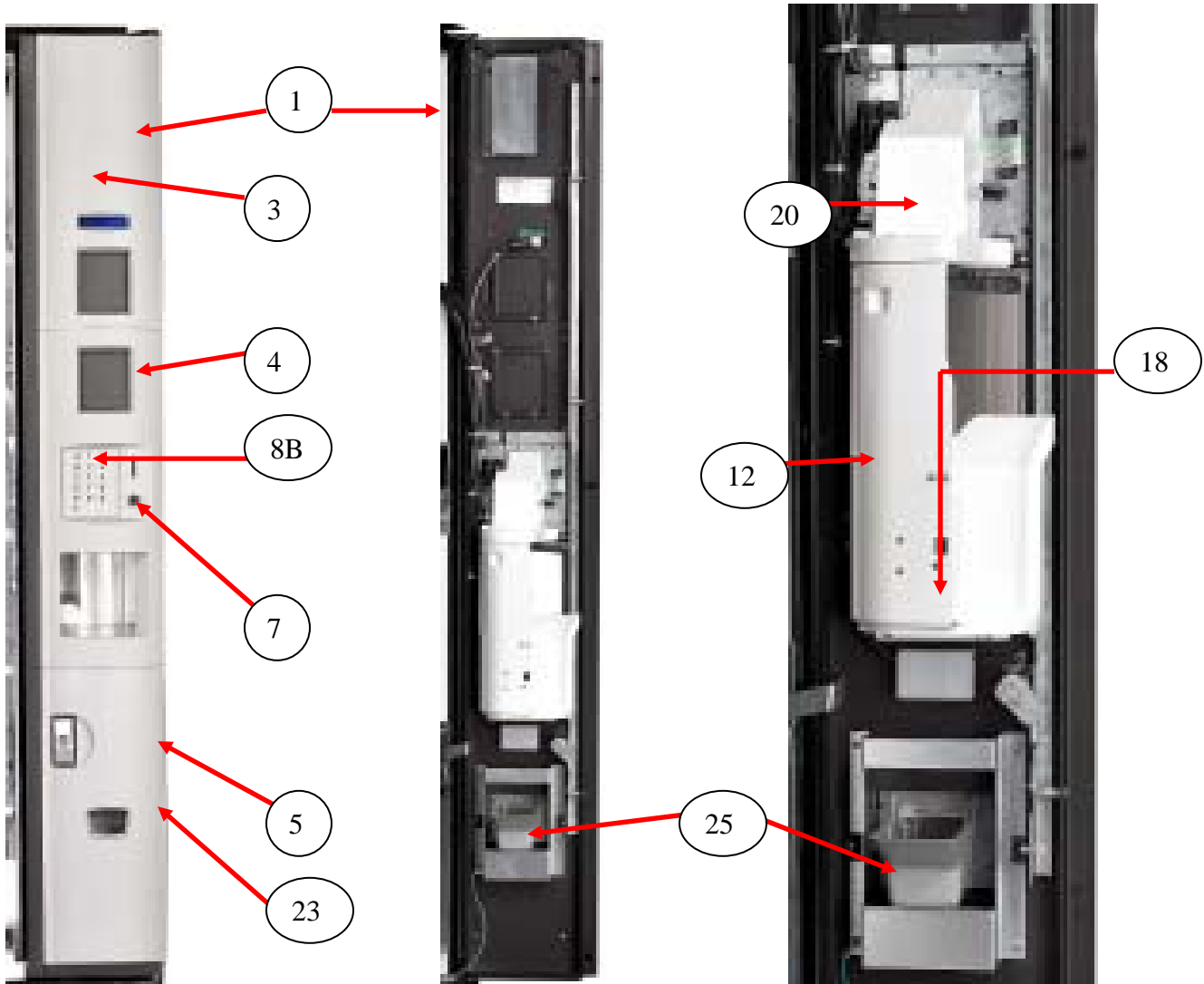

SERVICE DOOR (OUTSIDE) All BevMax 4

ITEM	PART DESCRIPTION	No Knock Out	Knock Out	Milled Knockout
1	Service Door Assembly, Gray (need to order item 23 separately)	NA	Same	Same
	Service Door Assembly, Black (need to order item 23 separately)	NA	Same	Same
2	Weld Assembly Service Door	CR0001802	Same	Same
3	Assembly Bezel Top, Gray	CR0004307	CR0005757	CR0005760
	Assembly Bezel Top, Black	CR0004306	CR0005758	CR0005759
4	Bezel Center, Gray	NA	80182122	NA
	Bezel Center, Black	NA	80182123	NA
5	Bezel Bottom Electronic Lock, Gray (included in item 23)	80182118	NA	NA
	Bezel Bottom T Handle, Gray (included in item 23)	80182120	NA	NA
	Bezel Bottom Electronic Lock, Black (included in item 23)	80182119	NA	NA
	Bezel Bottom T Handle, Black (included in item 23)	80182121	NA	NA
6	Coin Return Button Bracket was CR0002303	CR0005650	NA	NA
7	Coin Return Button was 801,823,14x.x1	CR0007492	NA	NA
8A	Overlay, Keypad – Gray was 80388894	NA	NA	NA
8B	Keypad Cover, Gray	80182462	NA	NA
	Keypad Cover, Black	80182461	NA	NA
9	Keypad & Overlay, Membrane Switch Assembly with metal dome	80410142	NA	NA
10	Coin & Keypad Bracket Assembly	CR0001800	NA	NA
11	Keypad security Bracket	64705037	NA	NA
12	Assembly Port (with out LED's) was 64705440	80182496	NA	NA
13	Port Enclosure	80182400	NA	NA
14	Port Cam	80182409	NA	NA
15	Bracket and Motor Assembly (with notch)	64705400	NA	NA
16	Assembly Inner Cup Port	80182097	NA	NA
17	Vend Sensor Plate	64705360	NA	NA
18	Port Discharge Pad	80360122	NA	NA
19A	Vend Sensor Board Assembly, Port	CR0002851	NA	NA
19B	Port Sensor Cover/Housing	CR0002214	NA	NA
19C	Port Sensor Harness	80492750	NA	NA
19D	Vend Sensor with Harness	80492749	NA	NA
20	Motor Port Cover	80182068	NA	NA
21	Port Handoff Slide	80182103	NA	NA
22	Screw, Phil Pan 8 – 18 x5/8 (secures bezels to panel)	80030502	NA	NA
23	Assembly Electronic Lock, Gray	CR0004294	NA	NA
	Assembly T Handle, Gray	CR0004287	NA	NA
	Assembly Electronic Lock, Black	CR0004293	NA	NA
	Assembly T Handle, Black	CR0004288	NA	NA
24	Coin Insert Chute	80182355	NA	NA
25	Extended Coin Return Cup Assembly (also see Service Door Inside)	80182429	NA	NA
26	Port Circuit Board (top of port assy)	80492511	NA	NA
27	Keypad Cable Clamp with adhesive was 80480112	CR0005752	NA	NA

Part numbers & descriptions are subject to change with out notice. NA = Not applicable TBD = To be determined RB = Replaced by

SERVICE DOOR (INSIDE)

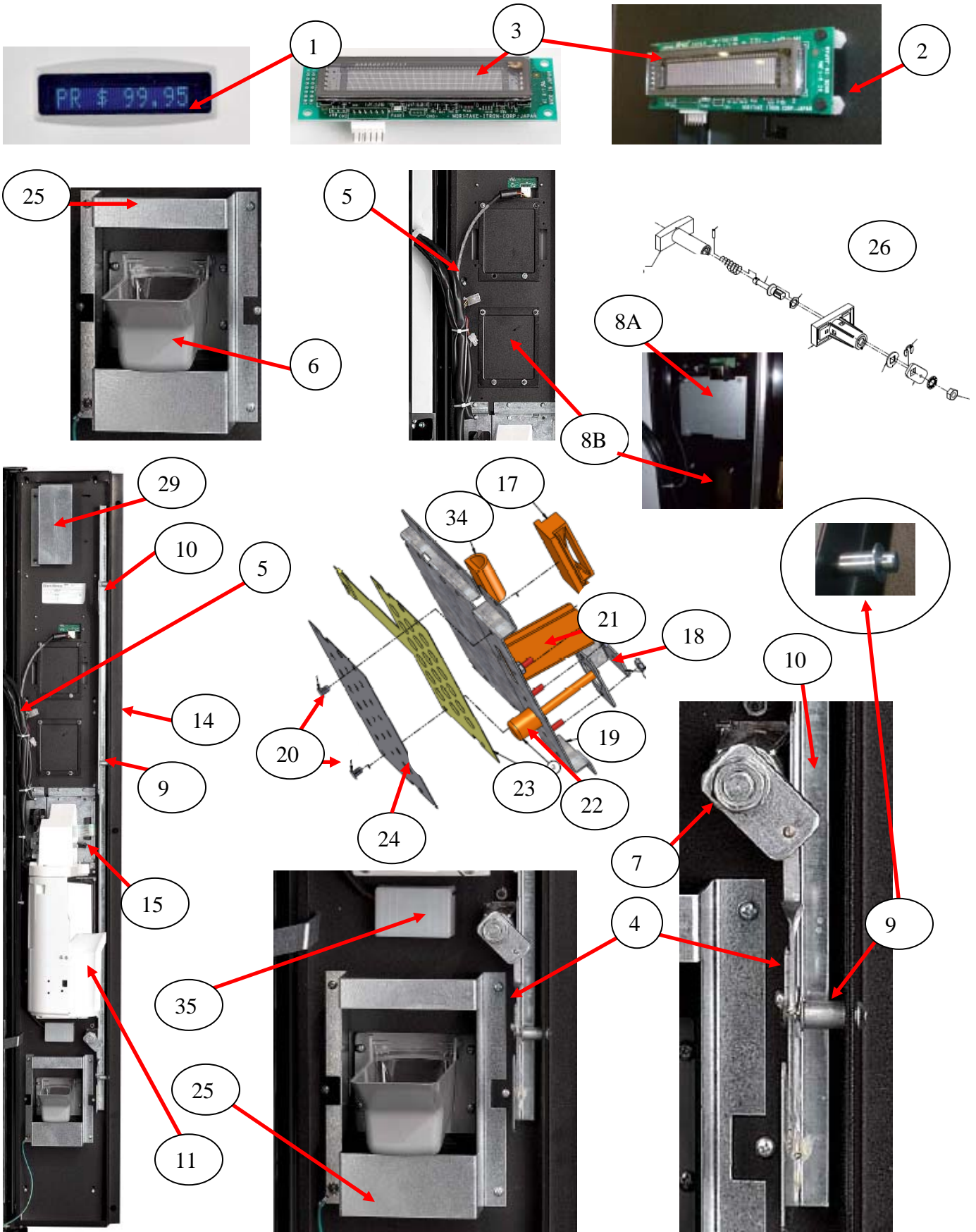

SERVICE DOOR (INSIDE)

ITEM	PART DESCRIPTION	DN5800-4 DN5800-E4	DN3800-4 DN3800-E4
1	Display Lens, Blue (part of top bezel assy)	NA	NA
2	Screw, Nylon Circuit Board Support	CR0002205	Same
3	Assembly Display (Noritake)	80492386	Same
4	Rod, Latch Bar	64705003	Same
5	Door Harness	804,928,36x.x1	Same
6	Extended Coin Return Cup Assembly	80182429	Same
7	Hex Nut, ½ - 20	80151802	Same
8A	Door Security Plate (not shown)	64705041	Same
8B	Validator Filler Plate (shown)	36005072	Same
9	Lock Bar Spacer Pin	80050412	Same
10	Lock Bar	64705002	Same
11	Enclosure, Port	80182400	Same
12	DEX Harness	80492827	Same
13	Hex Nut for DEX Harness	80080165	Same
14	Service Door Security Angle	CR0001817	Same
15	Coin Insert Assembly	CR0002043	Same
16	Compress Spring	80470154	Same
17	Keypad Cable Clamp with adhesive was 80480112	CR0005752	Same
18	Coin Return Button Bracket was CR0002303	CR0005650	Same
19	Coin & Keypad Bracket Assembly	CR0001800	Same
20	Panel Retainer Clip (holds membrane switch.& overlay to bracket)	CR0002204	Same
21	Coin Insert Chute	80182355	Same
22	Coin Return Button was 801,823,14x.x1	CR0007492	Same
23	Keypad & Overlay, Membrane Switch Assembly with metal dome	80410142	Same
24	Keypad Overlay, Gray was 80388894	NA	NA
25	Extended Change Cup Security Bracket was 647,050,58x.x3	CR0005680	Same
26	T Handle Assembly	80152600	Same
27	T Handle Security Bracket	64705063	Same
28	Hex Washer #29-34, T Handle	90150308	Same
29	Door Switch Striker Plate was 64705057 & 64705038	CR0005680	Same
30	Port Circuit Board (top of port assy.)	80492511	Same
31	E Lock Assembly	80520274	Same
32	E Lock Harness was 80492341	80492665	Same
33	E Lock PCA Cover Bracket Left Side	64705008	Same
34	Seal, Rubber "D" Gasket	NA	NA
35	Vend Sensor Board Assembly, Port	CR0002851	Same
36	Door Stop	64700075	Same

Part numbers & descriptions are subject to change with out notice.

NA = Not applicable TBD = To be determined RB = Replaced by

** Display Lens is sonic welded to top bezel and is not available as a separate item. See item 3 page 75.

GATE TRAY DETAIL

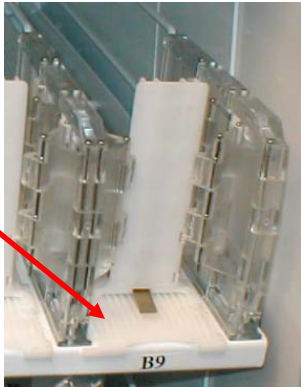
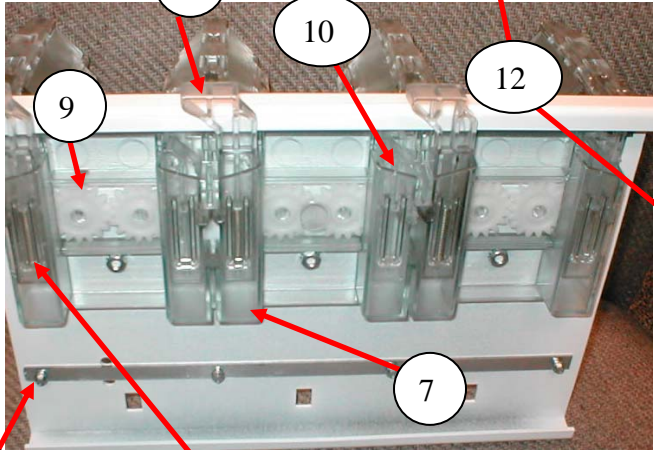
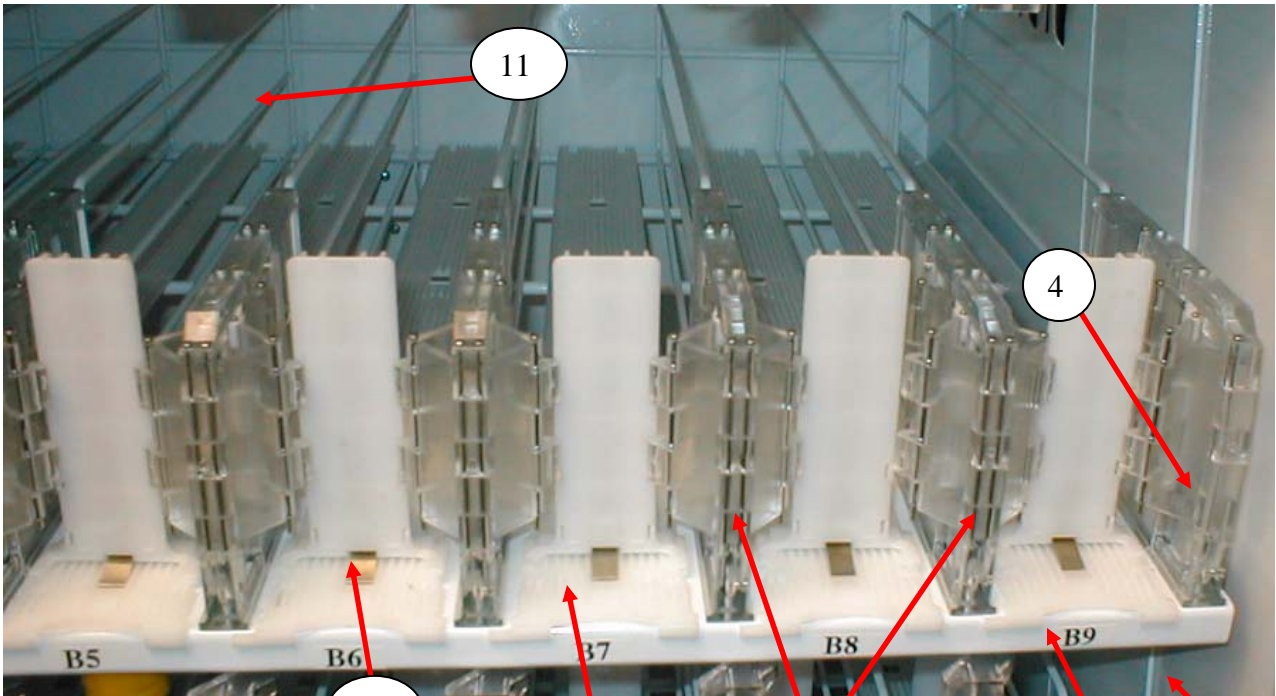

GATE TRAY DETAIL

ITEM	PART DESCRIPTION	DN5800-4 DN5800-E4	DN3800-4 DN3800-E4
1	Tray Assy., 9 Column	65700510	NA
	Tray Assy., 7 Column	NA	CR0013718
2	Chassis Tray, Tall Gate was 647,070,89x.x3, 647,071,50x.x3	CR0004077	NA
	Chassis Tray, Tall Gate	NA	CR0004139
3	Double Gate Assembly Kit (gate & 2 screws) was 64701110	65701260	Same
	Double Gate Assembly was 80182018	80182441	Same
4	Double Gate Assembly Right Kit (gate & 2 screws) was 64701120	65701240	Same
	Double Gate Assembly Right was 80182029	80182443	Same
5	Double Gate Assembly Left Kit (gate & 2 screws) was 64701130	65701250	Same
	Double Gate Assembly Left was 80182031	80182442	Same
6	Spring Gear Box	Part of #7	Same
7	Gear Box Assembly, 3 column	80182062	Same
	Gear Box Assy., 2 column	NA	80182196
8	Double Gate Drive Mech Target	Part of #7	Same
9	Double Gate Drive Mech Gear	Part of #7	Same
10	Double Gate Drive Mech Follower	Part of #7	Same
11	Tray Wire, Formed Domestic 9 Column (Wide)	80140293	NA
	Tray Wire, Formed Domestic 7 Column (Narrow)	NA	CR0000878
12	Slide with Product Pusher Assembly was 80182096	80182492	Same
13	Product Pusher Spring	80170113	Same
14A	Screw, Hex Head Hi Lo #6 X ½ (5/30/08 & higher)	1572269	Same
14B	Screw, Hex Washer #4-24 X ¾ (prior to 5/30/08)	80130417	Same
15	1/8" Socket, ¼" Drive	80010194	Same
	3/16" Socket, ¼" Drive	80010252	Same
16	Stabilizer, Tray Slide (8881-0049AH & higher)	80190501	Same
	Stabilizer, Tray Slide (prior to 8881-0049AH)	80190467	Same
Part numbers & descriptions are subject to change with out notice. NA = Not applicable TBD = To be determined RB = Replaced by			

AC DISTRIBUTION BOX

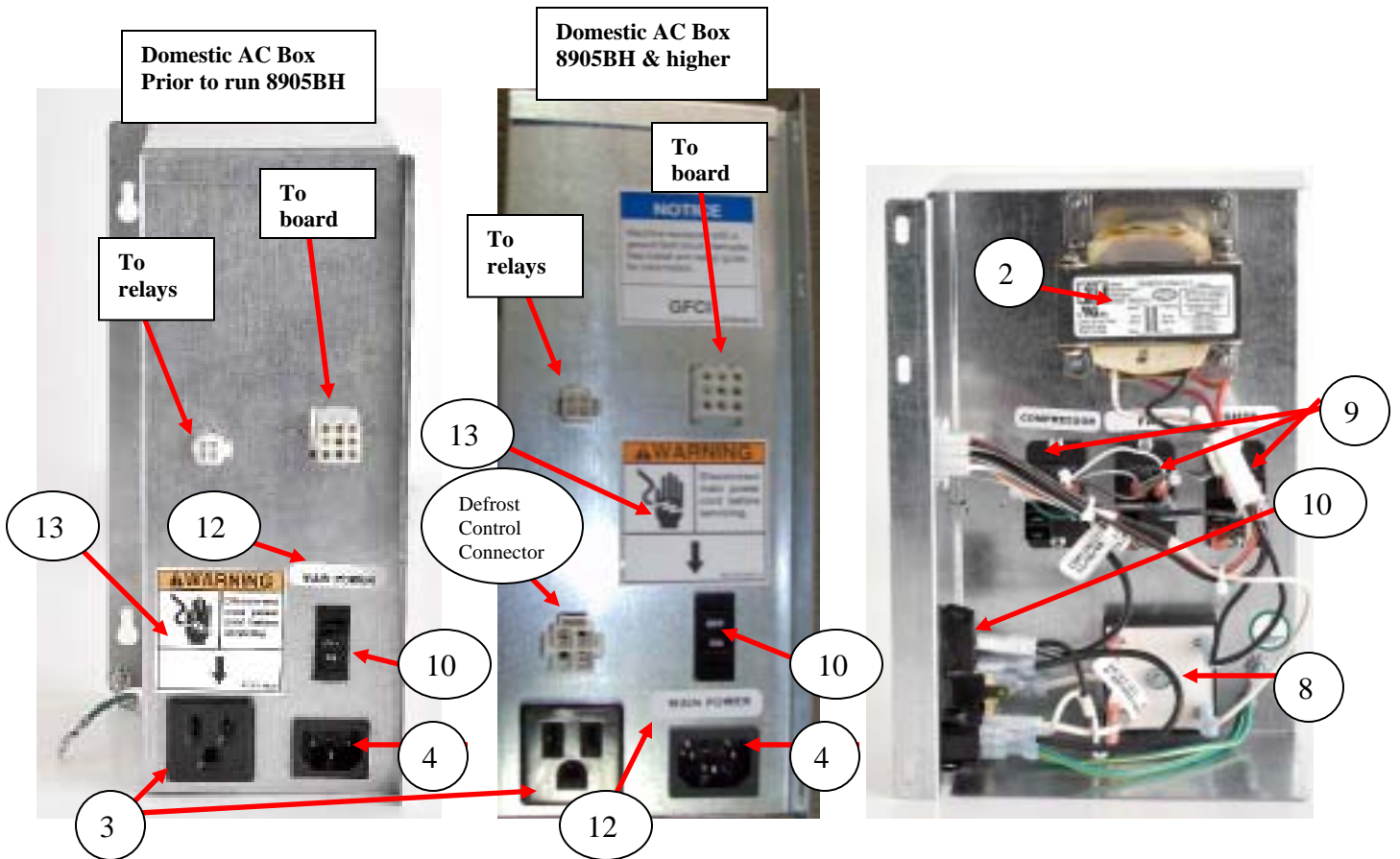
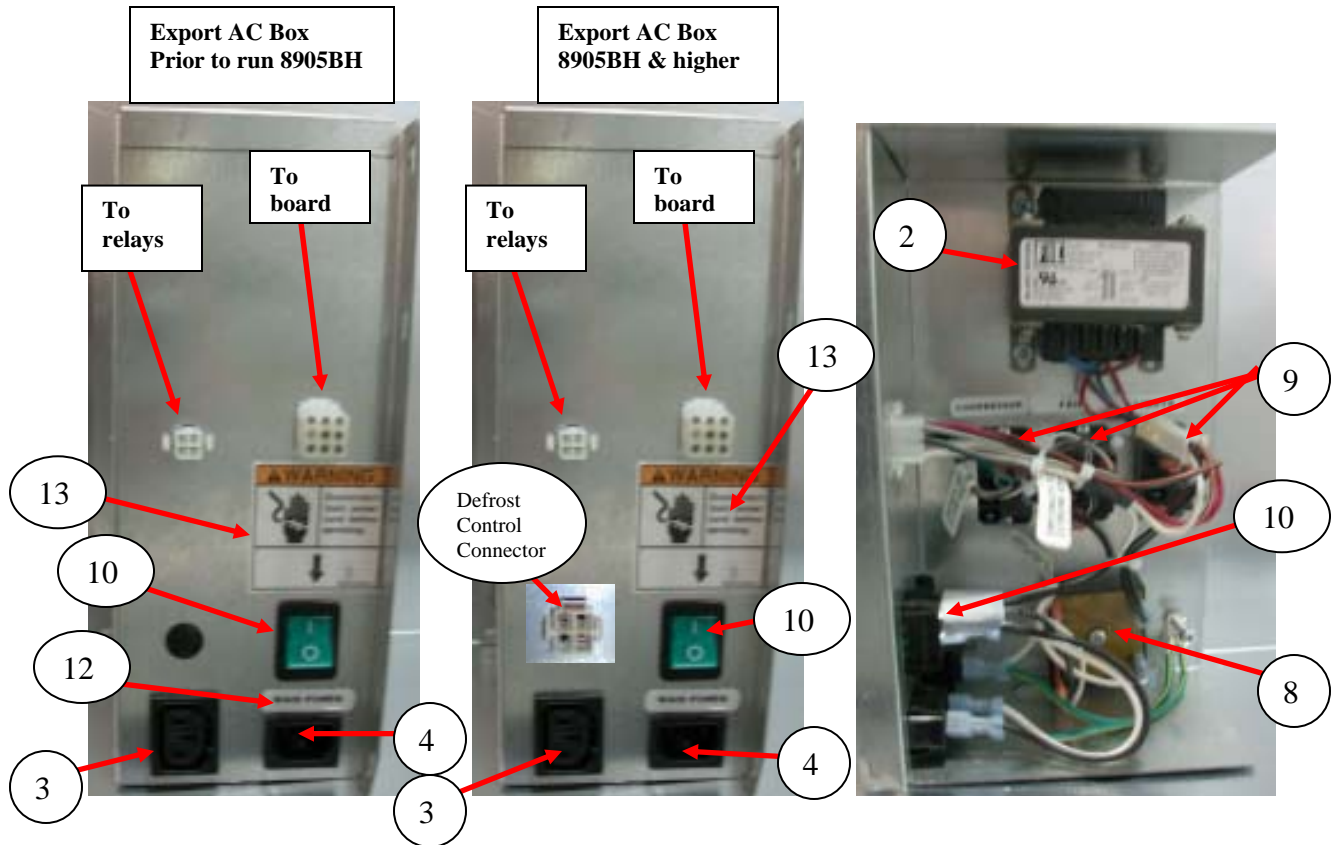

AC DISTRIBUTION BOX

ITEM	PART DESCRIPTION	DN5800-4 DN3800-4 Domestic	DN5800-E4 DN3800-E4 Export
1	Assembly AC Distribution Box, BevMax 4	65707070	657,070,90x.x3
2	Transformer, 120V / 24V, 60 Hz, 8A Domestic	804,925,14x.x1	NA
	Transformer, Export	NA	80492868
3	Outlet, 15 Amp, Grounded	W662	NA
	Receptacle, Panel Mount IEC 320	NA	80491114
4	Power Inlet Plug	80491362	Same
5	Harness, AC Power In	80492843	Same
6	Harness, Power Distribution	80492842	Same
7	Harness, Main Power – GFCI Inline	65701080	NA
8	Choke	80492692	80492691
9	Relay – Fan, Compressor, and Light	80420026	Same
10	Rocker Switch	80491515	80410112
11	Harness, Relay	80492840	Same
12	Main Power Label was 80386085	80388747	Same
13	Label, AC Box Power Disconnect	80387694	Same
14	Defrost Control Harness	80492871	Same
15	Harness, Compressor Power AC Box (connects to 80492871011)	80492895	Same
16			
17			
18			
19			
20			
21			
22			
23			
24			
25			
26			
27			
Part numbers & descriptions are subject to change with out notice. NA = Not applicable TBD = To be determined RB = Replaced by			

LIGHTING - Fluorescent

ITEM	PART DESCRIPTION	DN5800-4/3800-4 Domestic	DN5800-E4/3800-E4 Export
1	Horizontal (Upper) Light Assembly (1 Lamp)	65701210	65701130
2	Ballast Assembly, T8 Electronic 110V/60Hz (Horizontal Lamp) – 2 pin connector	80440126	80440134
3	Lamp Cover (22.6") & End Caps	80190477	Same
4	Light Harness, 120 Volt – 1 Lamp T8 (Upper Light Assy.)	80492852	804,928,84x.x1
	Lamp Holder, T8 Bi Pin - Leviton 23653 (Horizontal)	Use 4	NA
5	Fluorescent Lamp T8, 2' (OS #21718)	80470077	80470103
8	Canoe Clip – Lens Cover	80090361	Same
11	Vertical Light Assembly (2 Lamp)	65701100	65701140
12	Ballast Assembly, T8 Electronic 110V/60Hz (Vertical Lamps) - 9 pin connector	80440125	80440135
13	Assembly Lamp Channel 2' (Vertical)	647,061,70x.x3	Same
14	Lens, Fluorescent Lamp Vertical	80160328	Same
5	Fluorescent Lamp T8, 2' (OS #21718)	80470077	80410130
16	Light Harness, 120 Volt – 2 Lamp T8	80492844	804,928,85x.x1
17	Lamp Holder, T8 Bi Pin - Leviton 23652 (Vertical)	80492062	NA
8	Canoe Clip – Lens Cover	80090361	Same
Part numbers & descriptions are subject to change with out notice. NA = Not applicable TBD = To be determined RB = Replaced by			

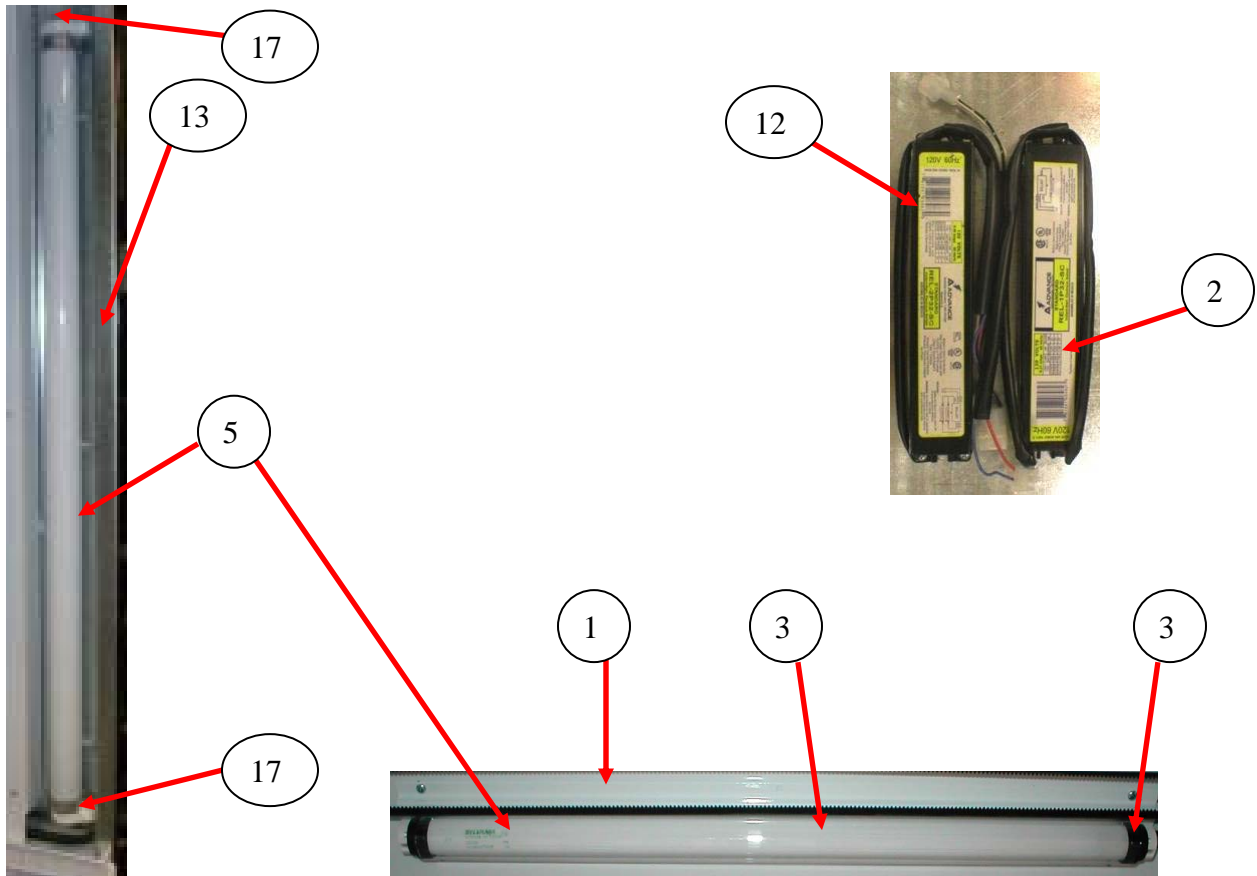

LIGHTING - LED

ITEM	PART DESCRIPTION	DN5800-4/3800-4 Domestic	DN5800-E4/3800-E4 Export
1	Horizontal (Upper) Light Assembly (1 Lamp) LED	65701160	Same
2	LED Module Assembly (does not include power supply switch mod line – 24vDC) was 65701190	65701180	Same
3	Harness, Relay extension, 5800-4 with LED's	80492886	Same
4	Lamp Assy., T5 600MM, 30 LED's 24vDC	9985061	Same
5	Harness, Power LED Lighting (to filter)	80492887	Same
6	Harness, LED Output (to relay)	80492888	Same
7	Harness, LED Adapter (to power adapter) was 80492889	9985055	Same
8	Relay	80420026	Same
9	Light Filter	AP380303	Same
10	Power Supply, Switch Mode (Line – 24vDC)	9985050	Same
11	Vertical (Side) Light Assembly (2 Lamp) LED	65701170	Same
12	Assy. Lamp Chanel 2' Modified	64706048	Same
13	Lens	80160328	Same
14	Canoe Clip – Lens Cover	80090361	Same
15			

Part numbers & descriptions are subject to change with out notice. NA = Not applicable TBD = To be determined RB = Replaced by

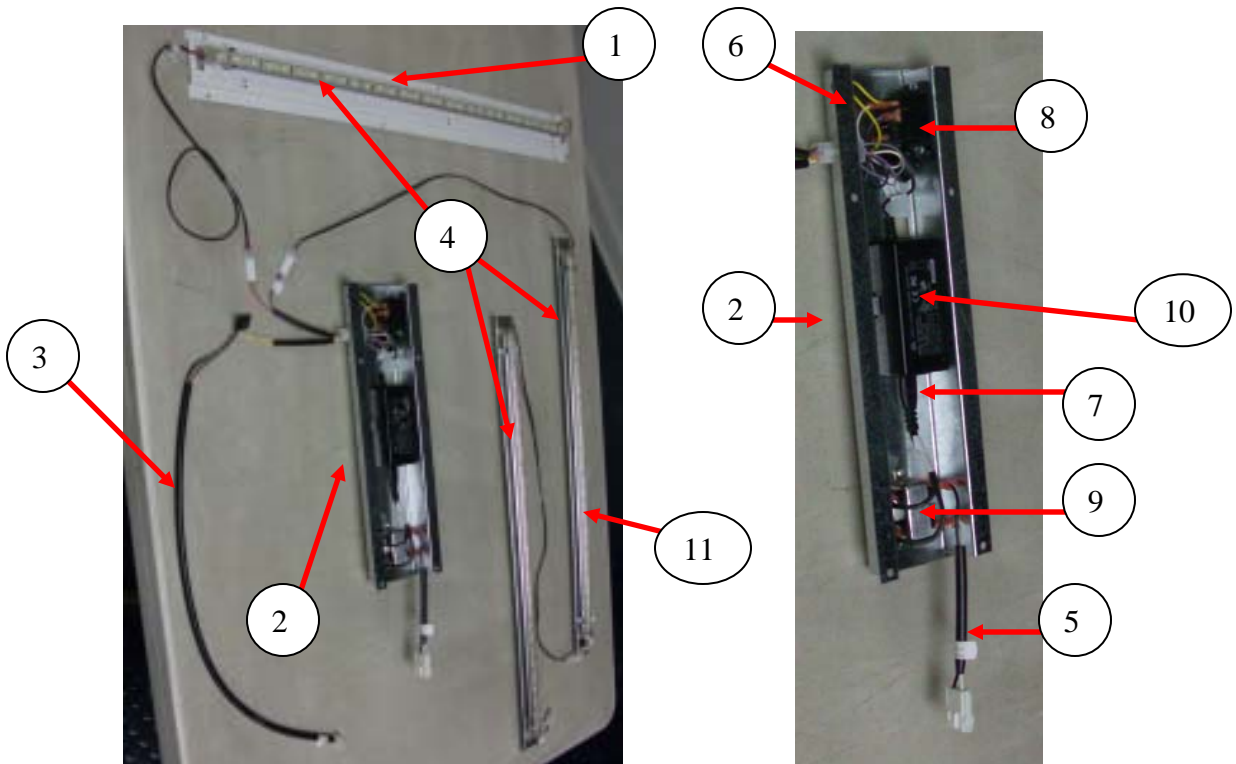

**REFRIGERATION UNIT BevMax 4
(with Plastic Evap Box - 9539-0032DJ and higher)**

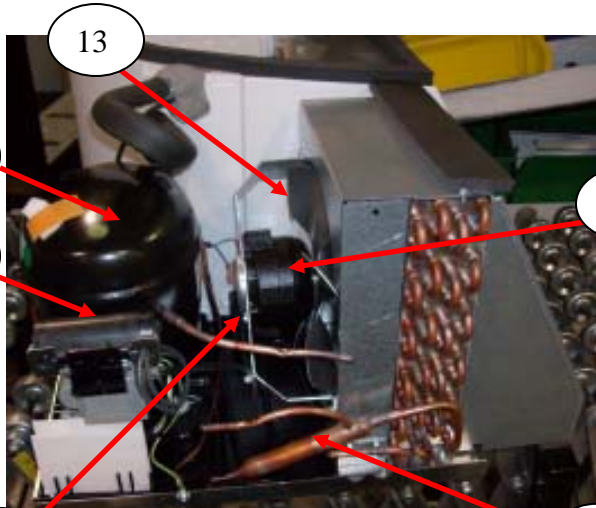
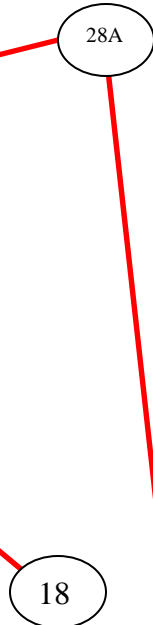
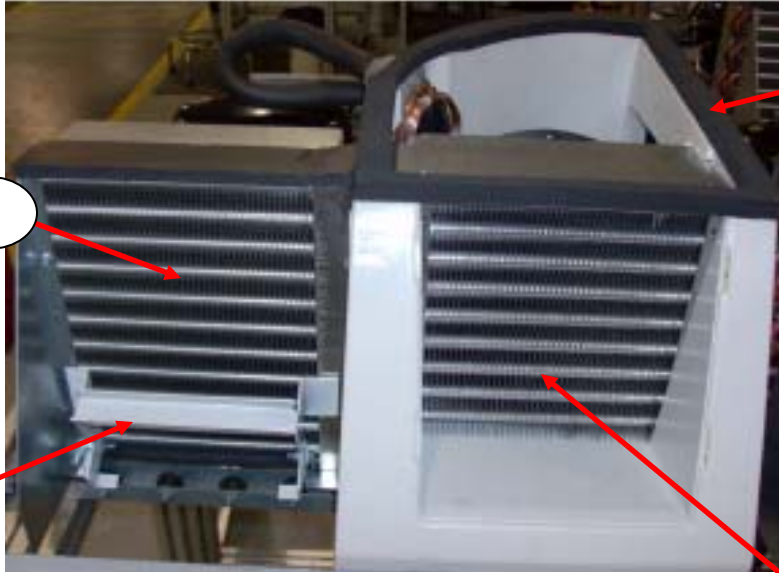

REFRIGERATION UNIT BevMax 4
(with Plastic Evap Box –9539-0032DJ and higher)

ITEM	PART DESCRIPTION	DN5800-4/3800-4 Domestic	DN5800-E4/3800-E4 Export
1A	Refrigeration Unit, 115V/60Hz Domestic Kit (Plastic Evap Box)	65701270	NA
	Refrigeration Unit, 230V/50Hz Export Kit (plastic Evap Box)	NA	65701290
2	Compressor Assy. FFU130HAX , 115V/60Hz Domestic	80250289	NA
2A	Compressor, Domestic (Embraco 513200620)	80250288	NA
2B	Compressor, Export	NA	CR0004162
3A	Overload, 115V Domestic (EM# 513554617)	80240213	NA
4A	Relay, 110V –Domestic (EM# 213516051)	80240216	NA
4B	Relay, 220V –Export	NA	CR0004863
5	Cover, Electrical	80240214	CR0004172
6A	Start Capacitor, 110V – Domestic (EM# 3252378)	80240218	NA
6B	Start Capacitor, 250V/50Hz Export	NA	CR0004174
7	Start Capacitor, End Cap Bottom Hole	80240220	NA
8	Bracket, Capacitor	80240217	NA
9	Drain Pan, Condensate – with Wicks	CR0002072	Same
10A	Assembly Condenser Fan, Domestic	CR0002309	NA
10B	Assembly Condenser Fan , 220V, 16W, 10” Export	NA	CR0004747
11A	Condenser Fan Motor, 9W Domestic was 80450193	80450187	NA
11B	Condenser Fan Motor, Export 16W	NA	CR0004145
12	Silencer	80210052	Same
13	Fan Blade, Condenser	80130866	CR0004748
14	Speed Nut	80080199	Same
15	Condenser Coil	CR0010358	Same
16	Dryer	80240129	Same
17	Grommet Compressor	90200057	Same
18	Evaporator Coil	CR0004391	Same
19	Accumulator	80240046	Same
20	Encapsulated Temperature Sensor	80492821	Same
21	Assembly Evaporator Fan 115V Energy Star (5 blade)	80450154	NA
	Assembly Evaporator Fan 230V/50Hz (5 blade)	NA	CR0004783
22	Evaporator Fan, 115V	80450151	NA
	Evaporator Fan, EBM (5 blade) 220-230/50 includes harness	NA	CR0004180
23	Defrost Control	CR0002421	Same
24	Evaporator Drain Pan Assy.	NA	Same
25	Condensate Drain P Trap	CR0002026	Same
26	Deck Handle Clamp	CR0002304	Same
27	Soaker	90580069	Same
28	Gasket Assembly – includes: A – CR0002551 Top Evaporator; B – CR0002552 Right side Evaporator; C – CR0005730 Lower Right side air gasket	CR0002615	Same
29	Refrigeration Deck Clamp	CR0002203	Same
30	Grill	CR0007259	Same

Part numbers & descriptions are subject to change with out notice. NA = Not applicable TBD = To be determined RB = Replaced by

**REFRIGERATION UNIT BevMax 4
(with Metal Evap Box prior to 9539-0032DJ)**

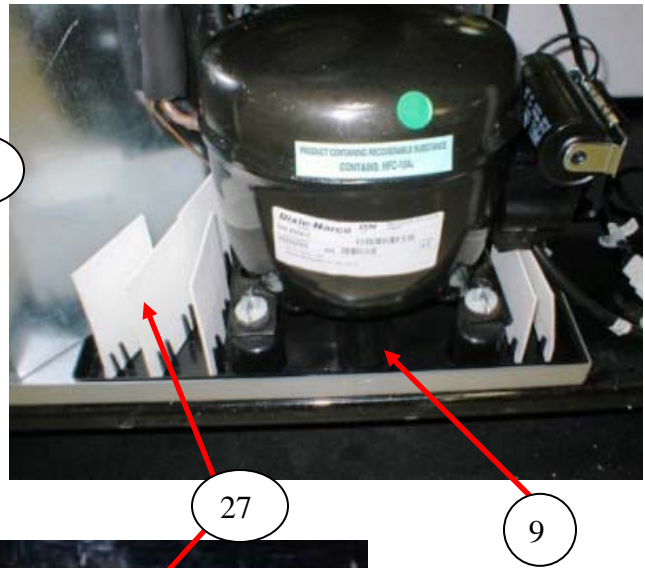
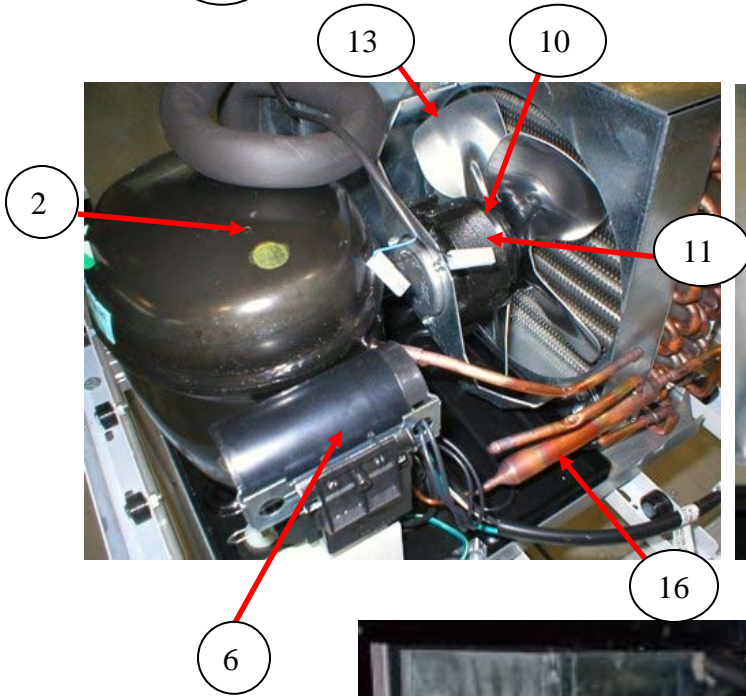
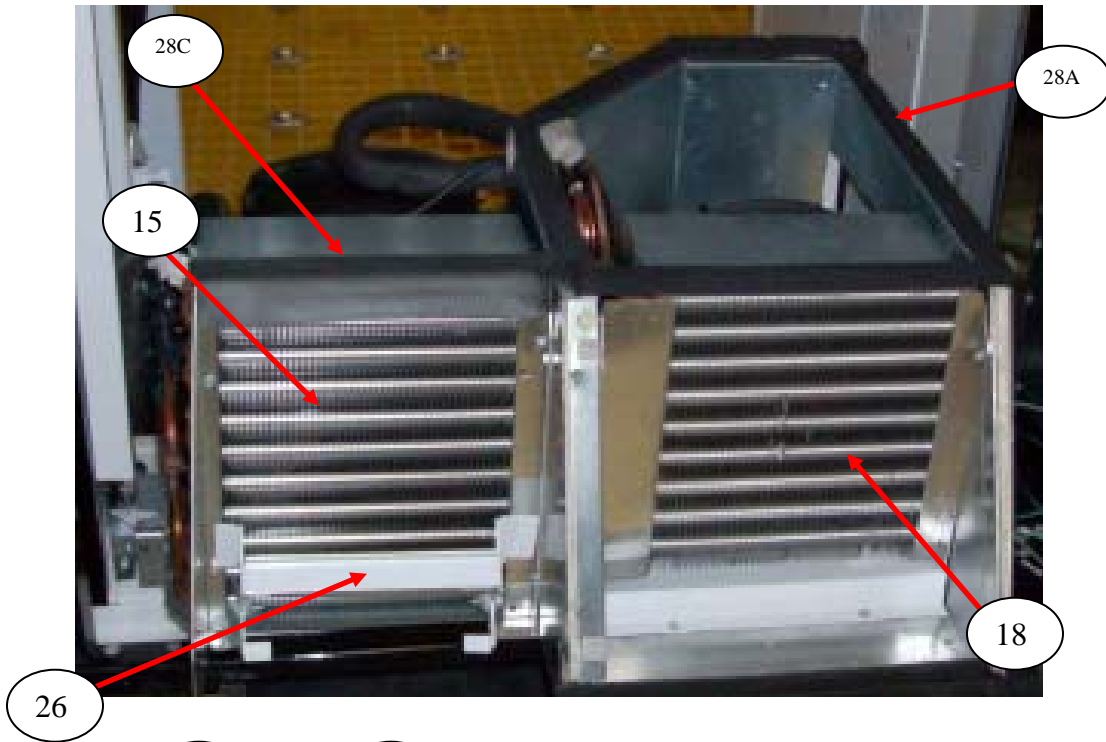

REFRIGERATION UNIT BevMax 4
(with Metal Evap Box prior to 9539-0032DJ)

ITEM	PART DESCRIPTION	DN5800-4/3800-4 Domestic	DN5800-E4/3800-E4 Export
1A	Refrigeration Unit, 115V/60Hz Domestic Kit was 65704000	65701270	NA
	Refrigeration Unit DN2028 C Kit, 230V/50Hz Export Kit	NA	CR0004811
2	Compressor Assy. FFU130HAX , 115V/60Hz Domestic	80250289	NA
2A	Compressor, Domestic (Embraco 513200620)	80250288	NA
2B	Compressor, Export	NA	CR0004162
3A	Overload, 115V Domestic (EM# 513554617)	80240213	NA
4A	Relay, 110V –Domestic (EM# 213516051)	80240216	NA
4B	Relay, 220V –Export	NA	CR0004863
5	Cover, Electrical	80240214	CR0004172
6A	Start Capacitor, 110V – Domestic (EM# 3252378)	80240218	NA
6B	Start Capacitor, 250V/50Hz Export	NA	CR0004174
7	Start Capacitor, Cap	80240220	NA
8	Bracket, Capacitor	80240217	NA
9	Drain Pan, Condensate – with Wicks	CR0002072	Same
10A	Assembly Condenser Fan, Domestic	CR0002309	NA
10B	Assembly Condenser Fan , 220V, 16W, 10” Export	NA	CR0004747
11A	Condenser Fan Motor, 9W Domestic was 80250193	80450187	NA
11B	Condenser Fan Motor, Export 16W	NA	CR0004145
12	Silencer	80210052	Same
13	Fan Blade, Condenser	80130866	CR0004748
14	Speed Nut	80080199	Same
15	Condenser Coil	80260079	Same
16	Dryer	80240129	Same
17	Grommet Compressor	90200057	Same
18	Evaporator Coil was 80260081	80260079	Same
19	Accumulator	80240046	Same
20	Encapsulated Temperature Sensor	80492821	Same
21	Assembly Evaporator Fan 115V Energy Star (5 blade)	80450154	NA
	Assembly Evaporator Fan 230V/50Hz (5 blade)	NA	CR0004783
22	Evaporator Fan, 115V	80450151	NA
	Evaporator Fan, EBM (5 blade) 220-230/50 includes harness	NA	CR0004180
23	Defrost Control was 80280084	CR0002421	Same
24	Evaporator Drain Pan Assy.	CR0001890	Same
25	Condensate Drain P Trap	CR0001296	Same
26	Deck Handle Clamp	CR0002304	Same
27	Soaker	90580069	Same
28	Gasket Assembly – includes A – 80210047 Top Evaporator; B - 80210048 Right side Evaporator; C - 80210051 Top Condenser ; D- 80210048 Right side air gasket	CR0001099	Same
29	Refrigeration Deck Clamp	CR0002203	Same
30	Grill	65704039	Same

Part numbers & descriptions are subject to change with out notice. NA = Not applicable TBD = To be determined RB = Replaced by

ELECTRONICS

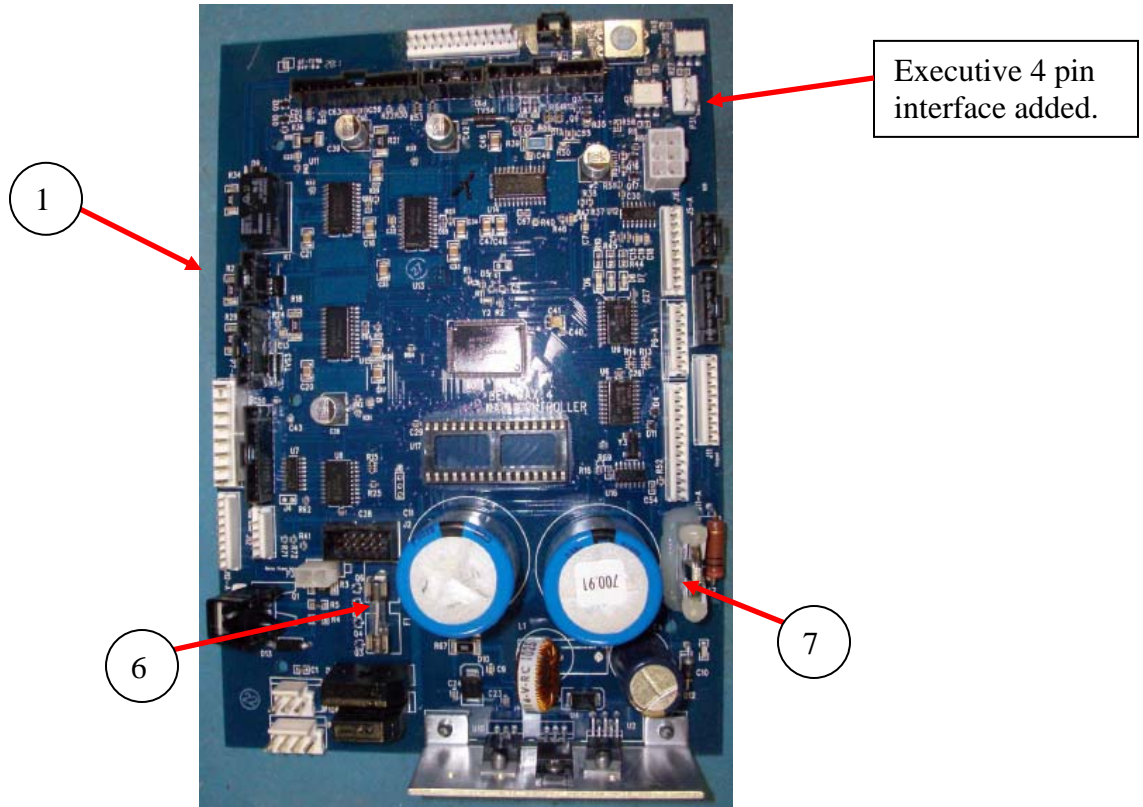

Pepsi/Generic BevMax 4 EXE Control Boards

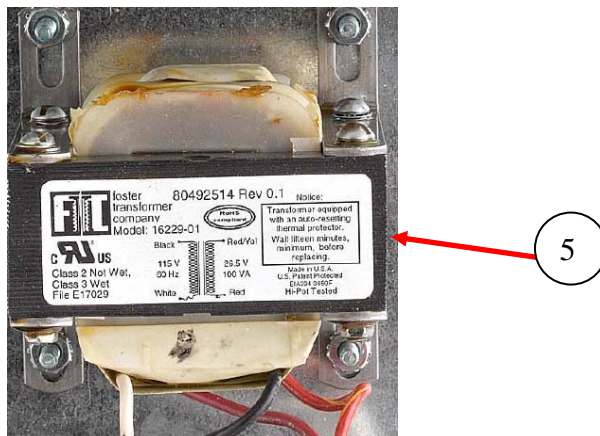
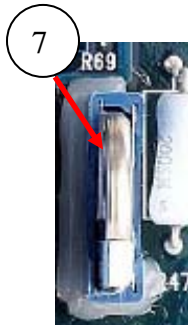
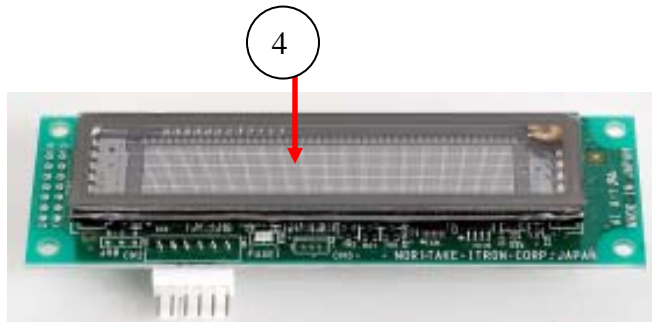
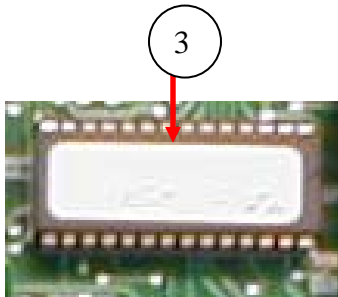

ELECTRONICS

ITEM	PART DESCRIPTION	DN5800-4 DN5800-E4	DN3800-4 DN3800-E4
1	BevMax 4 Control Board Service Kit (Note: refer to CMS Tech Notice M099.# for older vender kits)	65701220	Same
	BevMax 4 Control Board Service Kit – Indonesia only	65700390	Same
2	Standoffs, .8 – 32 x 5/8 (was 80100175)	80190380	Same
3	EPROM, Firmware, BevMax 4 Board	80492770	Same
	EPROM, Firmware, BevMax 4 Board – Indonesia only	80492873	Same
4	Display Assembly (Noritake)	80492386	Same
5	Transformer – Domestic (shown)	804,925,14x.x1	Same
	Transformer – Export (not shown)	80492868	Same
6	Fuse, 3 Amp 5 X 20mm Sloblo (on Control Board)	80480116	Same
7	Battery, 3 Volt Lithium (CR20332)	80492045	Same
8	Encapsulated Temperature Sensor	80492821	Same
9	Choke, Evaporator Fan Assembly & Lighting/AC Dist Box – Domestic	80492692	Same
	Choke, Evaporator Fan Assembly & Lighting/AC Dist Box – Export	80492691	Same
10	Board Y Motor	80492532	Same
11	Motor XY System was 80450184	80450189	Same
12	Control Board Cover	CR0001619	Same
13	Delivery (Picker) Cup Base Board was 80492765	80492916	Same
14	Motor, Port & Delivery Cup	80450161	Same
15	Port Vend Sensor with Harness	80492749	Same
16	Port Circuit Board	80492511	Same
17	Relay – Fan, Compressor, & Light	80420026	Same
18	Triteq Lock 701 Gullo Elk Grove Village, IL 60007 Phone 847-640-7002		
19	Controller Mounting Bracket	64700098	Same
20	Standoff, Richco	80190380	Same
Part numbers & descriptions are subject to change with out notice. NA = Not applicable TBD = To be determined RB = Replaced by			

HARNESSES

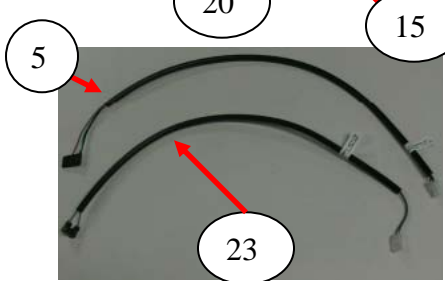
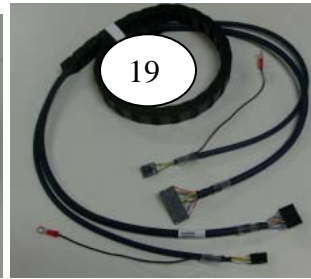
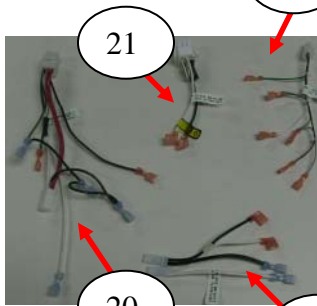
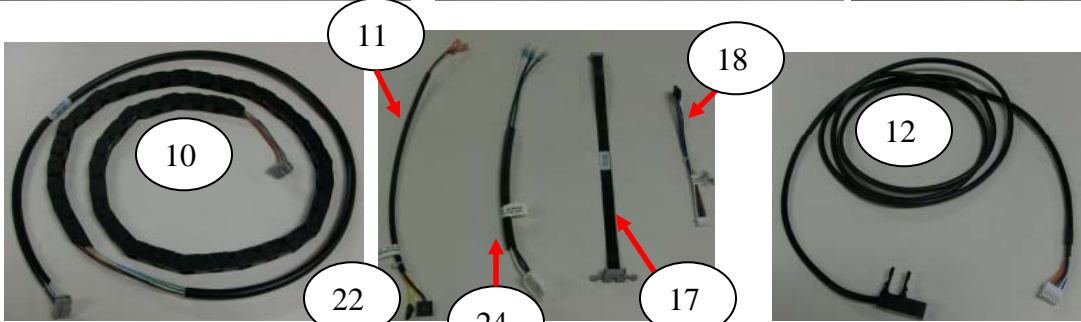
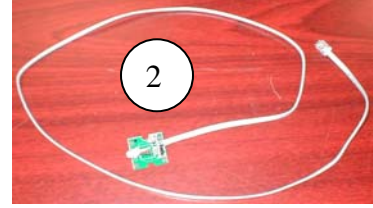
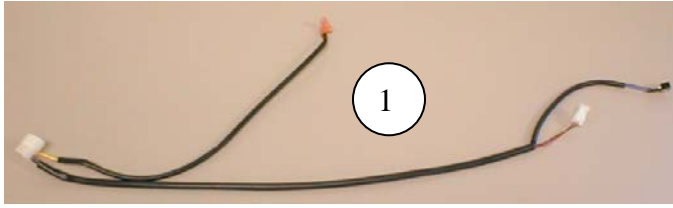

HARNESSES

ITEM	PART DESCRIPTION	FROM/TO	DN5800-4 DN5800-E4	DN3800-4 DN3800-E4
1	Harness, Electronic Lock	12 pin plug to E Lock board was 804,923,41x.x1	80492665	Same
	(E-lock venders only)	2 connectors to door switch		
		1 jack in top of port		
		2 pin cap to top port lock board		
2	Harness, Key Sensor	Phone jack to top port lock board (TriTeq supplied only)	NA	NA
3	Harness, Door Bundle 44" long	Black & grey hrns 12 pin flat black plug to P2 of board, 4 pin white plug to port motor, 7 pin flat white plug to port board. Black hrns 10 pin flat white plug to PJ11 of board, 10 pin flat black plug to key pad. Black & black hrns 6 pin white plug to J16 or board, 6 pin white cap to mdb mech, 6 pin white cap to mdb peripheral, 2 pin white plug to electronic lock if used. Grey hrns 7 pin flat black plug to P6 of board, 6 pin flat white plug to display.	80492836	Same
4	Harness, X Motor, 74" long	8 pin flat black at P15, 4 pin white plug to motor	80492825	Same
5	Relays Extension Harness, 23" long	10 pin flat black at P7 to 4 pin white plug at AC Distribution Box	80492828	Same
6	Harness, AC Distribution Interior Power, 28" long	3 pin white plug at P1 to 9 pin white cap at AC Distribution Box, 2 pin white plug at evaporator fan, 2 pin plug to 2 lamp ballast harness, 3 pin white plug to 1 lamp ballast harness	80492819	Same
7	Harness, Evaporator, 80" long	2 spade plugs to evaporator fan harness to 2 pin white plug from AC Box Harness	80492848	Same
	Harness, Evaporator Fan	Connects to Fan	80492467	Same
8	Harness, Lighting 2 Lamp	9 pin white plug to ballast, 2 pin white cap to 2 pin white plug from AC Distribution Box	80492844	Same
9	Harness, Top Light 1 Lamp	2 pin white cap from horizontal light to 2 pin white plug from lighting harness	80492852	Same
10	Harness, Y Motor E Chain	10 pin Gray at J1 of Y board, 10 pin Gray to delivery cup harness was 80492479	CR0013743	Same
11	Harness, Dual Door Switch, E-Lock, 14" long	6 pin flat black at P10 to Double Door Switch	80492867	Same
	Harness, Single Door Switch	6 pin flat black at P10 to Single Door Switch, 3 pin flat black to J3	80492823	Same
12	Encapsulated Temp Sensor	6 pin plug at J12 to Temp Sensor 87" long	80492821	Same
13	Harness, Port Cup Bottom – Vend Sensor	4 pin plug to bottom of Port Cup	80492750	Same
14	Harness, Main Power 198" long	Detachable GFCI Power Cord	65701080	Same
	Cord, Power UK	Detachable, 3 pin 78" long	80492566	Same
	Note →	For more detachable power cords see page 96 item 18		
15	Harness, AC Power In	In AC Distribution Box 2 white caps, 2 red flag, 2 blue spade connectors	80492843	Same
16	Harness, DEX 36" long	4 pin flat black connector at J5	80492827	Same
17	Harness, Cup to E-Chain	10 pin Gray at J3 Picker Cup Board to Y E Chain (Black Ribbon Harness)	80492374	Same
18	Harness, Board to Y Motor	6 pin flat black at P1 Y Board to 6 pin white to Y Motor	80492421	Same
19	Harness, X/Y E Chain, 56" long	14 pin flat black at P14 controller to 10 pin flat black at P6 Y Board, 5 pin flat black at P8 controller to 4 pin flat black at P3 Y Board	80492826	80492926
20	Harness, Power Dist.	9 pin cap to relays & transformer	80492842	Same
21	Harness, Choke Output	9 pin plug to AC Dist. Box Choke	80492049	Same
22	Harness, Relay AC Box	4 pin cap to relay harness, compressor relay, fan relay, light relay	80492840	Same
23	Power Interrupt Sw. (Motor By Pass) 21" long	2 pin white plug to P3	80492824	Same
24	Harness, Compressor Extension 23" long	3 "U" shaped connectors from overload/relay to 3 pin white socket to item 28	80492849	Same
25	Harness, Compressor Power Domestic	3 pin white plug to item 27 - 115" long	80492829	Same
	Harness, Compressor Power Export	3 pin white plug to item 27 - 115" long was 80492893	80492934	Same
26	Harness, Defrost Control	2 blue flag connectors to AC Box, 2 blue spade connectors to Defrost Control	80492871	Same
27				
28				

Part numbers & descriptions are subject to change with out notice.
 NA = Not applicable TBD = To be determined RB = Replaced by

LABELS / DECALS / MISC.

Note: Graphics change frequently.

Contact your Crane Merchandising Systems Representative for current graphic parts & part numbers.

ITEM	PART DESCRIPTION	DN5800-4 DN5800-E4	DN3800-4 DN3800-E4
1	Thermometer	80140155	Same
2	Price Sheet .35 – 1.10	80387751	Same
	Price Sheet 1.15 – 1.85	80387752	Same
	Price Sheet 1.90 – 3.75	80387753	Same
3	Label, Selection - BevMax 4 (A1 to E9 / A1 to E7)	80385726	CR0004953
4	Label, Warning “DO NOT TILT”	80386829	Same
5	Programming Card, Quick Reference	CR0005011	Same
6	Label, Coin Mech	803,853,25x.x1	Same
7	Decal, Side Cabinet – Black	W215	Same
	Decal, Side Cabinet – Pepsi	CR0001270	Same
	Decal, Side Cabinet – Aquafina	80388890	Same
8	Decal , Glass Door – Black	80388984	80388983
	Decal , Glass Door – Euro Gray	80388852	80388856
	Decal , Glass Door – Pepsi ‘09	80388853	80388857
	Decal , Glass Door – Aquafina	80388854	80388858
9	Decal, Cup Base – Black	80388586	Same
	Decal, Cup Base – Pepsi	80388566	Same
	Decal, Cup Base – Aquafina	80388567	Same
10	Decal, Sleeve – Black Straight	803,884,87x.x1	Same
	Decal, Sleeve – Pepsi Straight	803,884,76x.x1	Same
	Decal, Sleeve – Aquafina Straight	803,884,84x.x1	Same
11	Wiring Diagram, Domestic Fluorescent Lighting	803,888,47x.x1	Same
	Wiring Diagram, Domestic LED Lighting	80388952	Same
	Wiring Diagram, Export Fluorescent Lighting	80388916	Same
	Wiring Diagram, Export LED Lighting	80388953	Same
12	Generic BevMax 4 Manual, Service / Operation / Parts – 8882AH	80390462	Same
13	Generic BevMax 4 Manual, Installation SetUp Guide – 8882AH	80390463	Same
14	Overlay Keypad – Gray was 80388894	NA	NA
15	Label, Factory XY Settings	80388804	Same
16	Label, Warning Ramp	80388543	Same
17	Shipping Bracket & Bolt Instruction Sheet	80390443	Same
18	Cord, Power Detachable Denmark	80492900	Same
	Cord, Power Detachable Israel	80492902	Same
	Cord, Power Detachable South Africa	80492904	Same
	Cord, Power Detachable Australia	80492905	Same
	Cord, Power Detachable Europe Shuko	80492905	Same
Part numbers & descriptions are subject to change with out notice. NA = Not applicable TBD = To be determined RB = Replaced by. Contact Dixie Narco for other available graphics.			

Screws

(diagrams are for shape reference only)

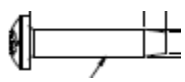

A1



A2

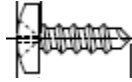

A3

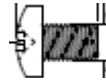

A4

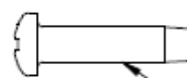

A5



A6

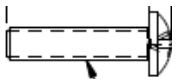

A7

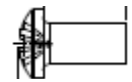

A8



A9

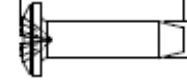

A10



A11

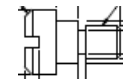

A12

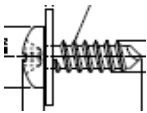

A13



A14

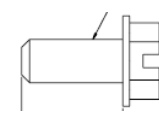

A15

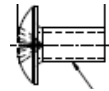

A16

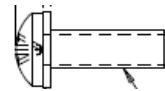

A17

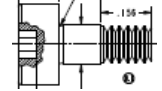

A18

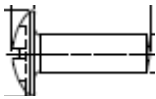

A19

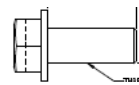

A20

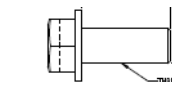

A21

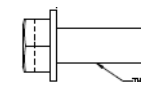

A22

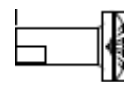

A23

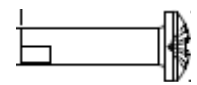

A24

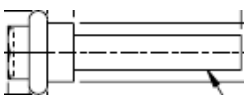

A25

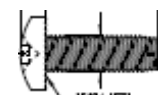

A26

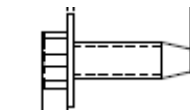

A27



A28

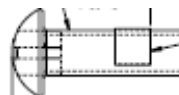

A29

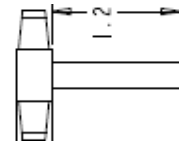

A30



A31

not available



A33

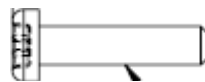

A34

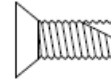

A35

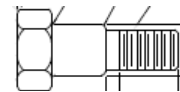

A36

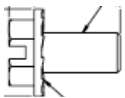

A37



A38

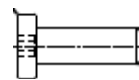

A39

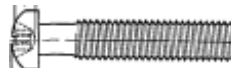

A40

SCREWS

ITEM	PART NUMBER	PART NAME AND DESCRIPTION
A1	80030446	Screw, Phil Pan Head 1/4 - 20 x 1 1/4"
A2	80030422	Screw, Phil Pan #8 - 32 x 3/8"
A3	80030418	Screw, Phil Pan w/out washer self drilling, #8 - 18 x 1/2"
A4	80030434	Screw, Phil Pan Swage Form #8 - 32 x 1/4"
A5	80030499	Screw, Phil Pan #2-32 x 3/8"
A6	80030501	Screw, Phil Pan, #2-32 x 1/2"
A7	80030479	Screw, Phil Pan #4-24 x 1/2"
A8	80020257	Screw, Pan Head 8 - 32
A9	80020284	Screw, Hex Head 1/4-28 X .5
A10	80030494	Screw, Phil Pan #8 - 32 x 5/8"
A11	80030428	Screw, Phil Pan Form #10 - 32 x 1 1/4"
A12	80020255	Screw, Fl Flstr Shoulder #10 - 32 x 1/4"
A13	80030423	Screw, Phil Pan Sems with washer, #8 - 18 x 1/2"
A14	80030436	Screw, Self Tapping, 1/4 - 20 x 5/8"
A15	80030468	Screw, Hex Washer 8x5/8"
A16	80020265	Screw, Phil Truss #10 - 32 x 3/8"
A17	80030503	Screw, Phil Pan with lock washer #4 - 40 x 3/8"
A18	80020236	Screw, Shoulder #4-40
A19	80030431	Screw, Phil Pan #8-18x1/2"
A20	80030454	Screw, Hex Head 10-16x .50
A21	80030449	Screw, Hex Tapping .250-20
A22	80030452	Screw, Hex Washer Head 1/4-20
A23	80030497	Screw, Phil Pan #8-18x.375"
A24	80030502	Screw, Phil Pan #8-18x5/8"
A25	80030417	Screw, 4-24 HiLo
A26	80030421	Screw, Phil Pan Swage Form #8-32x1/2"
A27	80030451	Screw, Hex Washer Head #8-18x1/2"
A28	80020248	Screw, Pan Head #6-32 X 1/4
A29	80030415	Screw, Nylock #8-32x1/2"
A30	80030529	Screw, Wing 1/4 - 20 x 1 1/4 molded nylon (for shipping bracket)
A31	CR0002205	Screw, Nylon (Circuit Board Support – Display)
A32	80030541	Screw, TEK Zinc #20 X .750
A33	AP13100035	Screw, Fl. Torx Tap 1/4-20 X 1/2
A34	80030488	Screw, Hex w/ washer 8-32 x 3/8
A35	80030433	Screw, Phillips Flat 10-32 X .5
A36	80050387	Screw, Shoulder 1/4-20 X .35
A37	80030540	Screw, Machine w/ lock 10-24 X 3/8
A38	1572269	Screw, Hex w/ Head, Hi-Lo #6 X 1/2
A39	80020250	Screw, Hex Button Head 10-32 X 5/8
A40	80020285	Screw, 10-32 X 1.375
A41		
A42		
A43		
A44		
A45		
A46		

Part numbers & descriptions are subject to change with out notice.
 NA = Not applicable TBD = To be determined RB = Replaced by

NUTS, WASHERS, BOLTS, & MISC. HARDWARE
 (diagrams are for shape reference only)

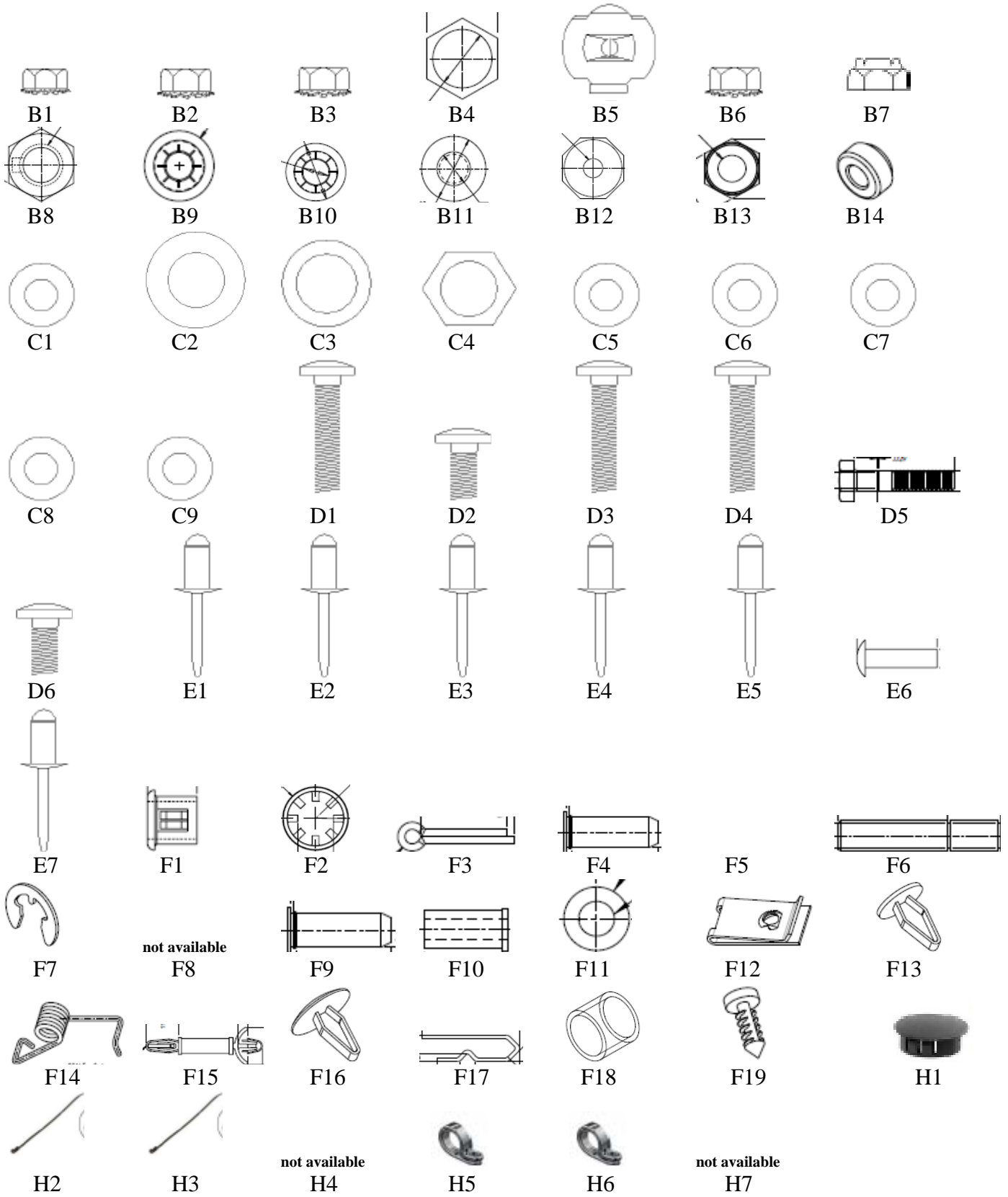

WASHERS, BOLTS, & MISC. HARDWARE

ITEM	PART #	PART NAME AND DESCRIPTION	ITEM	PART #	PART NAME AND DESCRIPTION
B1	80080156	Hex Nut, #10 - 32	E1	90110054	Pop Rivet, Black 1/8"
B2	80080157	Hex Nut, 1/4 - 20	E2	80110081	Pop Rivet, Steel (Zinc Plated) 1/8"
B3	80080154	Hex Nut, #8 - 32	E3	80110079	Pop Rivet, Steel (Zinc Plated) 3/16"
B4	80080165	Hex Nut, Dex Plug	E4	80110065	Pop Rivet, Aluminum 1/8" White
B5	90080085	Speed Nut	E5	48909023	Pop Rivet, SS 187
B6	80080166	Hex Nut with washer, #10 - 24	E6	19609043	Rivet, Bulbex 3/16 Black
B7	80080155	Elastic Stop Nut, #8 - 32	E7	80110066	Pop Rivet, Steel 3/16 Black
B8	80080152	Nut Jam Lock 5/16	E8		
B9	80090297	Push Nut .187 X .437	E9		
B10	80090302	Push Nut ID .250	E10		
B11	80080147	Push Nut Washer Cap Type	E11		
B12	80030478	Nylon Insert Lock Nut 1/4 - 20			
B13	80080195	Nut, 10-32 Nylock	F1	80190448	Nylon Bushing, Heyco 2867
B14	80080178	Nut, 1/4-20 Pemnut C420-1	F2	80090351	Retaining Ring
B15			F3	80090329	Cotter Pin .076 dia. .5 long
B16			F4	80100176	Pin Self Clinching .250 x 3/4
B17			F5		
			F6	80050375	Pin Belt Tensioner Idler PVT
C1	80070156	Washer, Lock .261 ID	F7	80090336	E Ring Ext 1/4 #E-25
C2	80070139	Washer, Nylon .189 x .375 x .031	F8	80190380	Standoff Richo RLCBSR401SR
C3	90070122	Washer, .260 ID x .687 OD Flat	F9	80100177	Pin Self Clinch .250 x 1
C4	90150308	Washer, Hex #29-34 (T-Handle)	F10	80100175	Standoff, Clinch 8 - 32 5/8
C5	80070152	Washer, .191 ID x .5 OD x .054T Flat	F11	80181813	Nylon Spacer #8 ID, .312 OD, .5
C6	48909130	Washer, SS Flat #10	F12	80090249	Tinnerman Clip, U-Nut 1/4 - 20
C7	80070144	Washer, Flat 18 Gauge 17/64ID x 5/8OD	F13	80090273	Clip, Canoe 254-12020-99
C8	80070165	Washer, Flat 3/8 Steel	F14	80140197	Belt Tensioner Spring
C9	80070146	Washer, Flat 15/32ID X 59/64OD	F15	80190489	Standoff, Circuit Board
C10			F16	80090361	Clip, Canoe Natural (Lens)
C11			F17	90090188	Clip, Retainer Compressor
C12			F18	80530071	Spacer, 1/4ID X .275
C13			F19	80090299	Clip, Pine Tree Rivet
C14			F20		
			F21		
D1	80020249	Bolt, Carriage 1/4 - 20 x 2.5	F22		
D2	80020251	Bolt, Carriage 10-24 x .82			
D3	CR0004761	Bolt, 1/4-20 X 1.75	H1	AP420040	Plug, Dome Black .50
D4	80030542	Bolt, Carriage 1/4-20 X 2	H2	90190201	Wire Tie, 7 1/2"
D5	80040071	Bolt, Hex 1/4-20 X 1.25	H3	90190100	Wire Tie, 4"
D6	80020256	Bolt, Carriage 10-24 X .82	H4	W223	Wire Tie, Twist
D7			H5	80090251	Clamp, Nylon 5/16" White
D8			H6	90190189	Clamp P 1" Heyco 3390
D9			H7	CR0004146	Clamp, .250 Push Fin Base
D10			H8		
D11			H9		
D12			H10		
D13			H11		
D14					
D15					

Part numbers & descriptions are subject to change with out notice.
 NA = Not applicable TBD = To be determined RB = Replaced by